



HELSINKI UNIVERSITY OF TECHNOLOGY
Department of Electrical and Communications Engineering

Timo Smura

TECHNO-ECONOMIC ANALYSIS OF IEEE 802.16a-BASED
FIXED WIRELESS ACCESS NETWORKS

Thesis submitted in partial fulfillment of the requirements
for the degree of Master of Science in Technology
Helsinki, April 27, 2004

Supervisor

Professor Timo O. Korhonen

Instructor

Matti Swan, M.Sc. (Tech)

Author:	Timo Smura	
Name of the Thesis:	Techno-economic analysis of IEEE 802.16a-based fixed wireless access networks	
Date:	27.04.2004	Number of pages: 124
Department:	Department of Electrical and Communications Engineering	
Professorship:	S-72 Communications Engineering	
Supervisor:	Prof. Timo O. Korhonen	
Instructor:	Matti Swan, M.Sc. (Tech)	
<p>The popularity of broadband Internet access services has increased significantly among the Finnish households during the past few years. At the same time, the development of wireless technologies has been rapid. As a result of these developments, fixed wireless access (FWA) networks have been proposed as a possible competitor to other broadband access technologies, such as digital subscriber line (DSL) systems.</p> <p>Recently published technical standards from IEEE and ETSI are expected to improve the position of FWA networks as an alternative access technology. Certified interoperability, lower prices, non-line-of-sight capabilities, and customer-installable end-user terminals are claimed to fix the major problems of earlier generations of FWA systems.</p> <p>In the thesis, a techno-economic analysis was carried out to determine the feasibility and competitiveness of IEEE 802.16a-based FWA networks in providing broadband Internet access to residential customers. A techno-economic framework and tool developed in several European research projects was applied to analyze the networks.</p> <p>The results of the analyses show that the cost structure of FWA networks is not currently competitive with DSL in densely populated urban and suburban areas. This results from the high equipment prices and relatively low coverage and range of the networks. In the future, however, FWA networks will provide access also for portable and mobile terminals, making the business case more favorable.</p>		
Keywords:	Fixed wireless access networks, broadband, IEEE 802.16a	

Tekijä:	Timo Smura	
Työn nimi:	IEEE 802.16a-standardin mukaisten kiinteiden langattomien liityntäverkkojen teknis-taloudellinen analyysi	
Päivämäärä:	27.04.2004	Sivumäärä: 124
Osasto:	Sähkö- ja tietoliikennetekniikan osasto	
Professori:	S-72 Televiestintäjärjestelmät	
Työn valvoja:	Prof. Timo Korhonen	
Työn ohjaaja:	DI Matti Swan	
<p>Laajakaistaisten Internet-yhteyksien suosio on kasvanut suomalaisten kotitalouksien keskuudessa voimakkaasti viime vuosina. Samanaikaisesti myös langattomien verkko-tekniologioiden kehitys on ollut vauhdikasta. Kiinteitä langattomia laajakaistaverkkoja (FWA = Fixed Wireless Access) onkin ehdotettu uudeksi kilpailijaksi muiden laajakaistaisten liityntäverkkotekniikoiden, kuten digitaalisten tilaajayhteyksien (DSL = Digital Subscriber Line), rinnalle.</p> <p>IEEE:n ja ETSI:n vastikään julkaisemien teknisten standardien odotetaan parantavan FWA-verkkojen asemaa kilpailevana liityntäteknikkana. Sertifioitu yhteensopivuus, alhaisemmat hinnat, toiminta olosuhteissa ilman näköyhteyttä ja itse asennettavat asiakaspään laitteet ovat tekijöitä, joiden väitetään korjaavan aikaisempien laitesukupolvien ongelmat.</p> <p>Tässä diplomityössä pyrittiin teknis-taloudellisella analyysillä selvittämään IEEE 802.16a-standardiin perustuvien FWA-verkkojen kilpailukykyä ja soveltuvuutta laajakaistaisten Internet-yhteyksien tarjoamiseen kotiasiakkaille. Tutkimuksessa hyödynnettiin useissa eurooppalaisissa tutkimusprojekteissa kehitettyjä menetelmiä ja työkaluja.</p> <p>Tutkimuksen tulokset osoittavat, ettei FWA-verkkojen kustannusrakenne ole nykyisellään kilpailukykyinen DSL-verkkojen kanssa tiheästi asutetuilla kaupunki- tai taajama-alueilla. Tämä on seurausta laitteiden korkeista hinnoista ja verkkojen suhteellisen pienestä kantamasta ja peittoalueesta. Tulevaisuudessa FWA-verkkoja voidaan kuitenkin hyödyntää myös liityntäverkkona kannettaville ja mobiililaitteille, mikä parantaa tekniikan kaupallisia hyödyntämismahdollisuuksia.</p>		
Avainsanat:	Kiinteät langattomat liityntäverkot, laajakaista, IEEE 802.16a	

Preface

This Master's Thesis completes my work for the Master of Science degree in the Helsinki University of Technology. Most of the work for the thesis was carried out in the research department of Elisa Corporation during the year 2003.

The Master's Thesis marks the end of a certain period in my academic career, and the beginning of another. I wish to express my gratitude to those people that have supported and encouraged me in my studies during these years.

First, I wish to express my gratitude to the Communications Laboratory and especially to my supervisor, Professor Timo O. Korhonen, for his guidance during the course of my work.

Furthermore, I would like to thank my instructor Matti Swan for his guidance and support during the project, as well as all my colleagues at Elisa Research for creating a lively and stimulating working atmosphere and also for getting my mind off the thesis project from time to time.

I am also grateful to all my friends from inside and outside the university. All work and no play would have certainly made me a very dull boy. Special thanks to Teemu Koski for proofreading the thesis.

Finally, I owe my deepest gratitude to my family, and especially to my girlfriend Kati. I wish to thank them all for their patience and support during my studies.

Helsinki, April 27th, 2004

Timo Smura

Table of contents

1	<u>INTRODUCTION</u>	1
1.1	BACKGROUND	1
1.2	PURPOSE AND OBJECTIVES OF THE THESIS	2
1.3	SCOPE OF THE THESIS	2
1.4	STRUCTURE OF THE THESIS	3
1.5	OWN CONTRIBUTION	4
2	<u>BROADBAND NETWORKS AND SERVICES</u>	6
2.1	BROADBAND NETWORKS	6
2.1.1	BACKBONE AND REGIONAL NETWORKS	7
2.1.2	ACCESS NETWORKS	7
2.1.3	BUILDING NETWORKS AND MULTI DWELLING UNITS	8
2.1.4	HOME NETWORKS	9
2.2	ACCESS NETWORK ALTERNATIVES	9
2.2.1	FIBER OPTICS	9
2.2.2	DIGITAL SUBSCRIBER LINES (DSL)	10
2.2.3	CABLE MODEM NETWORKS	12
2.2.4	ETHERNET IN THE FIRST MILE (EFM)	13
2.2.5	POWER LINE COMMUNICATIONS (PLC)	14
2.2.6	DIGITAL VIDEO BROADCASTING (DVB)	15
2.3	OPERATORS AND REGULATION	16
2.3.1	NETWORK AND SERVICE OPERATORS	16
2.3.2	SIGNIFICANT MARKET POWER	17
2.3.3	DSL NETWORK SERVICES	18
2.4	BROADBAND SERVICES AND APPLICATIONS	19
2.4.1	BROADBAND DEFINITION	19
2.4.2	NETWORK, COMMUNICATIONS, AND VALUE-ADDED SERVICES	19
2.4.3	APPLICATIONS AND THEIR REQUIREMENTS	20
2.5	CHAPTER SUMMARY	21
3	<u>FWA TECHNOLOGIES AND STANDARDS</u>	22
3.1	FWA STANDARDS AND INTEROPERABILITY	23
3.1.1	IEEE 802 LMSC	23
3.1.2	ETSI BRAN	25
3.1.3	WiMAX FORUM	26
3.2	FWA FREQUENCY BANDS	27
3.3	NETWORK TOPOLOGIES	28
3.4	POINT-TO-MULTIPOINT NETWORK ARCHITECTURE	29
3.5	LINE-OF-SIGHT IN POINT-TO-MULTIPOINT NETWORKS	30
3.6	MODULATION AND CODING	32
3.6.1	SINGLE-CARRIER MODULATION METHODS	32
3.6.2	MULTICARRIER MODULATION USING OFDM	33
3.6.3	CODING METHODS	34
3.7	MULTIPLE ACCESS AND DUPLEXING	34
3.7.1	DUPLEXING METHODS	35
3.7.2	MULTIPLE ACCESS METHODS	35
3.8	ANTENNAS	35

3.8.1	ANTENNA CHARACTERISTICS AND PARAMETERS	35
3.8.2	BASE STATION SECTOR ANTENNAS	36
3.8.3	CPE ANTENNAS	37
3.8.4	ADVANCED ANTENNA SYSTEMS	37
3.9	COMMERCIALLY AVAILABLE FWA SYSTEMS	38
3.10	CHAPTER SUMMARY	39
4	<u>FWA NETWORK DIMENSIONING AND PLANNING</u>	<u>40</u>
<hr/>		
4.1	FREQUENCY BAND AND SYSTEM SELECTION	40
4.1.1	FREQUENCY BAND SELECTION	40
4.1.2	SYSTEM CHARACTERISTICS	42
4.2	CHANNEL MODELS FOR FWA NETWORKS	42
4.2.1	PATH LOSS MODELS	43
4.2.2	FADING MODELS	44
4.3	PATH LOSS MODELS FOR THE THESIS	44
4.3.1	IEEE 802.16 PATH LOSS MODEL	45
4.3.2	PATH LOSS MODEL FOR RURAL AREAS	47
4.4	CAPACITY PLANNING	49
4.4.1	AGGREGATE TRAFFIC AND CONCENTRATION	49
4.4.2	ADAPTIVE MODULATION AND AVERAGE SECTOR CAPACITY	50
4.4.3	NUMBER OF SECTORS AND BASE STATIONS	51
4.5	COVERAGE PLANNING	52
4.5.1	LINK BUDGETS	52
4.5.2	SERVICE AVAILABILITY VS. FADE MARGINS	54
4.5.3	RANGE OF 3.5 GHz FWA BASE STATIONS	54
4.6	FREQUENCY PLANNING AND CHANNEL ASSIGNMENTS	55
4.6.1	CO-CHANNEL INTERFERENCE	55
4.6.2	CHANNEL ASSIGNMENTS	55
4.7	CHAPTER SUMMARY	56
5	<u>TECHNO-ECONOMICS OF BROADBAND ACCESS NETWORKS</u>	<u>57</u>
<hr/>		
5.1	INPUTS TO THE TECHNO-ECONOMIC ANALYSES	58
5.1.1	SCENARIOS AS INPUTS	58
5.1.2	CAPITAL AND OPERATIONAL EXPENDITURES	59
5.2	OUTPUTS FROM THE TECHNO-ECONOMIC ANALYSES	60
5.2.1	PROFITABILITY	60
5.2.2	CASH BALANCE CURVE	61
5.3	RISK AND SENSITIVITY ANALYSIS	62
5.3.1	SENSITIVITY, SCENARIO, AND SIMULATION ANALYSES	62
5.3.2	ADJUSTMENTS ON THE NPV FORMULA	63
5.3.3	RISK AND SENSITIVITY ANALYSIS IN THE THESIS	64
5.4	TECHNO-ECONOMIC ANALYSES USING THE TERA TOOL	64
5.4.1	TERA FRAMEWORK	64
5.4.2	SERVICE DEFINITION	66
5.4.3	ARCHITECTURE DEFINITION	67
5.4.4	NETWORK COMPONENTS	67
5.4.5	COMPONENT COST EVOLUTION	68
5.4.6	OPERATION, ADMINISTRATION, AND MAINTENANCE COSTS	70
5.4.7	RISK ANALYSES	71
5.5	CHAPTER SUMMARY	71

6	<u>ECONOMIC ANALYSIS OF FWA NETWORKS</u>	<u>72</u>
6.1	INPUT SCENARIOS	73
6.1.1	STUDY PERIOD	73
6.1.2	ENVIRONMENTAL SCENARIOS	73
6.1.3	SERVICE SCENARIOS	74
6.1.4	REGULATORY SCENARIOS	77
6.1.5	TECHNOLOGY SCENARIOS	78
6.1.6	ECONOMIC INPUTS	81
6.2	FWA NETWORK DIMENSIONING	81
6.2.1	CAPACITY PLANNING	81
6.2.2	COVERAGE PLANNING	82
6.2.3	FWA NETWORK SHOPPING LISTS	84
6.3	ADSL NETWORK DIMENSIONING	85
6.3.1	ADSL NETWORK SHOPPING LIST	86
6.4	ECONOMIC ANALYSIS	87
6.4.1	ECONOMIC FEASIBILITY OF FWA IN DIFFERENT SCENARIOS	88
6.4.2	REVENUE AND INVESTMENT BREAKDOWNS	88
6.4.3	FWA VS. ADSL	89
6.4.4	USER-INSTALLABLE CPES	90
6.5	SENSITIVITY ANALYSIS	90
7	<u>CONCLUSIONS</u>	<u>93</u>
7.1	RESULTS AND RECOMMENDATIONS	93
7.1.1	COVERAGE AND CAPACITY	93
7.1.2	ECONOMIC ANALYSIS	94
7.1.3	RECOMMENDATIONS	94
7.2	RELIABILITY AND VALIDITY	95
7.3	SUGGESTIONS FOR FUTURE RESEARCH	96
7.3.1	CHANNEL MODELS	96
7.3.2	ADVANCED SERVICES AND BUSINESS MODELS	96
8	<u>REFERENCES</u>	<u>98</u>
A	<u>APPENDICES</u>	<u>A-1</u>
A.1	NATIONAL FREQUENCY ALLOCATIONS FOR FWA SERVICES	A-1
A.2	FWA SPECTRUM FEE CALCULATION	A-2
A.3	LINK BUDGET CALCULATIONS	A-3
A.4	BACKGROUND DATA FOR THE ENVIRONMENTAL SCENARIOS	A-5
A.4.1	MUNICIPALITY TYPES	A-5
A.4.2	URBAN AND SUBURBAN AREAS	A-6
A.4.3	RURAL AREAS	A-6

List of Figures

FIGURE 1.1: PENETRATION OF BROADBAND INTERNET ACCESS IN FINNISH HOUSEHOLDS 1997-2003	1
FIGURE 1.2: STRUCTURE OF THE THESIS	3
FIGURE 2.1: BACKBONE, REGIONAL, AND ACCESS NETWORK DEFINITIONS	6
FIGURE 2.2: POSITIONING OF DIFFERENT TECHNOLOGIES IN THE BROADBAND NETWORK STRUCTURE	7
FIGURE 2.3: A BUILDING NETWORK BETWEEN AN ACCESS NETWORK AND HOME NETWORKS	8
FIGURE 2.4: THE FIBER-TO-THE-X (FTTX) CONCEPT	10
FIGURE 2.5: ADSL SYSTEM REFERENCE MODEL	11
FIGURE 2.6: DATA-OVER-CABLE NETWORK ARCHITECTURE	12
FIGURE 2.7: PLC SYSTEM ARCHITECTURE	14
FIGURE 2.8: REFERENCE MODEL FOR INTERACTIVE DVB SYSTEMS	15
FIGURE 2.9: THROUGHPUT AND QOS REQUIREMENTS OF SOME APPLICATIONS	20
FIGURE 3.1: IEEE 802 LAN & MAN REFERENCE MODEL	23
FIGURE 3.2: EXAMPLE OF A POINT-TO-MULTIPOINT NETWORK DEPLOYMENT	29
FIGURE 3.3: EXAMPLE OF A FIXED WIRELESS ACCESS NETWORK ARCHITECTURE	30
FIGURE 4.1: EXEMPLARY PATH LOSS CURVES	46
FIGURE 4.2: REPRESENTATIVE RADIO PATH IN WOODLAND	48
FIGURE 4.3: ATTENUATION IN VEGETATION AS A FUNCTION OF DISTANCE FOR A 3.5 GHz SIGNAL	49
FIGURE 4.4: POSSIBLE FREQUENCY REUSE PATTERNS USING 8 CHANNELS	55
FIGURE 5.1: EXAMPLE OF A CASH BALANCE CURVE	61
FIGURE 5.2: EXAMPLE OF A SENSITIVITY GRAPH	63
FIGURE 5.3: TERA FRAMEWORK FOR TECHNO-ECONOMIC EVALUATIONS	65
FIGURE 5.4: ATTRIBUTES OF REVENUE COMPONENTS IN TERA	66
FIGURE 5.5: ARCHITECTURE MODEL OF TERA TOOL	67
FIGURE 5.6: ATTRIBUTES OF COST COMPONENTS IN TERA	68
FIGURE 5.7: FORECAST FUNCTION FOR THE EVOLUTION OF MANUFACTURING VOLUME	69
FIGURE 5.8: TERA OA&M METHODOLOGY	70
FIGURE 6.1: PREDICTED BROADBAND PENETRATION	74
FIGURE 6.2: PREDICTED BROADBAND PENETRATION, BY THROUGHPUT CLASS	75
FIGURE 6.3: PREDICTED ANNUAL BROADBAND ACCESS TARIFFS	76
FIGURE 6.4: TECHNOLOGY SCENARIOS	78
FIGURE 6.5: FOUR CELLS COVERING A SQUARE-SHAPED AREA	83
FIGURE 6.6: FIBER BACKBONE NETWORK DIMENSIONING	86
FIGURE 6.7: RESULTS FROM ECONOMIC ANALYSIS	87
FIGURE 6.8: BREAKDOWN OF REVENUES	88
FIGURE 6.9: BREAKDOWN OF INVESTMENTS	89
FIGURE 6.10: SENSITIVITY GRAPH	91

List of Tables

TABLE 2.1: KEY FEATURES OF VARIOUS DSL TECHNOLOGIES	11
TABLE 2.2: IEEE 802.3AH PHYSICAL LAYER SPECIFICATIONS	13
TABLE 2.3: COMPARISON OF WIRED ACCESS NETWORK TECHNOLOGIES	21
TABLE 3.1: STANDARDS FOR WLAN AND FWA NETWORKS	27
TABLE 3.2: AVAILABLE FREQUENCY BANDS FOR FWA SYSTEMS IN FINLAND	27
TABLE 3.3: POINT-TO-MULTIPOINT FWA NETWORK CATEGORIZATION	31
TABLE 3.4: TECHNICAL FEATURES OF SOME COMMERCIAL 3.5 GHz FWA SYSTEMS	38
TABLE 4.1: TYPICAL CHARACTERISTICS OF FWA SYSTEMS IN DIFFERENT FREQUENCY BANDS	41
TABLE 4.2: CHARACTERISTICS OF THE 802.16 WIRELESSMAN™-OFDM BASED SYSTEM	42
TABLE 4.3: MODEL PARAMETERS FOR IEEE 802.16 CHANNEL MODELS	46
TABLE 4.4: NORMALIZED RANGES AND COVERAGE AREAS OF DIFFERENT MODULATIONS	51
TABLE 4.5: BASIC LINK BUDGET	52
TABLE 4.6: RECEIVER MINIMUM INPUT LEVEL SENSITIVITY	53
TABLE 4.7: COVERAGE PLANNING RESULTS: CELL RANGES IN DIFFERENT ENVIRONMENTS	54
TABLE 5.1: RESEARCH RELATED TO TECHNO-ECONOMICS OF BROADBAND NETWORKS	57
TABLE 5.2: SCENARIOS AND SCENARIO ATTRIBUTES	59
TABLE 5.3: VOLUME CLASS PARAMETERS	69
TABLE 6.1: ATTRIBUTES OF ENVIRONMENTAL SCENARIOS	73
TABLE 6.2: AVERAGE MONTHLY ADSL SUBSCRIPTION FEES IN FINLAND, VAT INCL.	75
TABLE 6.3: PREDICTED ANNUAL TARIFFS FOR NETWORK SERVICES, VAT EXCL.	76
TABLE 6.4: MARKET SHARE OF THE FWA OPERATOR	77
TABLE 6.5: NETWORK COMPONENTS AND THEIR PRICE EVOLUTION	79
TABLE 6.6: OPERATION AND ADMINISTRATION COSTS	80
TABLE 6.7: AVERAGE THROUGHPUT DEMAND OF SUBSCRIBERS	81
TABLE 6.8: NUMBER OF FWA SECTORS AND BASE STATIONS REQUIRED IN THE URBAN AREAS	82
TABLE 6.9: CAPACITY PLANNING RESULTS	82
TABLE 6.10: REQUIRED RANGE OF FWA BASE STATIONS	83
TABLE 6.11: COVERAGE PLANNING RESULTS	84
TABLE 6.12: FWA NETWORK SHOPPING LIST, URBAN AREAS	84
TABLE 6.13: FWA NETWORK SHOPPING LIST, SUBURBAN AND RURAL AREAS	85
TABLE 6.14: ADSL NETWORK SHOPPING LIST	86
TABLE 6.15: SENSITIVITY GRAPH CURVE SLOPES	91
TABLE A.1: LINK BUDGET, DIRECTIONAL CPE ANTENNAS, COVERAGE REQUIREMENT 90%	A-3
TABLE A.2: LINK BUDGET, DIRECTIONAL ANTENNAS, COVERAGE REQUIREMENT 99%	A-3
TABLE A.3: LINK BUDGET, INDOOR CPES, COVERAGE REQUIREMENT 90%	A-4
TABLE A.4: LINK BUDGET, INDOOR CPES, COVERAGE REQUIREMENT 99%	A-4
TABLE A.5: DEFINITIONS OF DIFFERENT MUNICIPALITY TYPES	A-5
TABLE A.6: CHARACTERISTICS OF DIFFERENT MUNICIPALITY TYPES	A-5
TABLE A.7: FINNISH RESIDENTIAL BUILDINGS AND DWELLINGS	A-5
TABLE A.8: STATISTICS FROM SOME DISTRICTS OF HELSINKI	A-6
TABLE A.9: TELEPHONE EXCHANGE AREAS IN RURAL NORTH KARELIA	A-6

Key concepts

Broadband service	Data service offering data rates of at least 256 kbps in both upstream and downstream directions
Fixed wireless access	Wireless access application in which the location of the end-user terminal and the network access point are fixed
IEEE 802.16a	Technical standard for fixed wireless access networks operating at frequencies below 11 GHz
Non-line-of-sight	Condition where a radio link between a transmitter and a receiver is obstructed by e.g. buildings or vegetation
Point-to-multipoint	Network topology in which a single network access point communicates directly with multiple end-user terminals
Techno-economics	Branch of science concentrating on analyzing the economic aspects of (new) technologies and related business models
WiMAX	Non-profit organization that promotes the deployments of fixed wireless access networks and certifies products conforming to the IEEE 802.16a standard

Acronyms

3G	3rd Generation (of mobile networks)
ADSL	Asymmetric Digital Subscriber Line
ARQ	Automatic Repeat Request
ASK	Amplitude Shift Keying
ATM	Asynchronous Transfer Mode
B-ISDN	Broadband Integrated Services Digital Network
BPSK	Binary Phase Shift Keying
BRAN	Broadband Radio Access Network
CAPEX	Capital Expenditures
CDMA	Code Division Multiple Access
CPE	Customer Premises Equipment
CSMA/CA	Carrier Sense Multiple Access / Collision Avoidance
DLC	Data Link Control (layer)
DOCSIS	Data-Over-Cable Service Interface Specification
DSL	Digital Subscriber Line
DSLAM	DSL Access Multiplexer
DVB	Digital Video Broadcasting
DVB-C	Digital Video Broadcasting - Cable
DVB-S	Digital Video Broadcasting - Satellite
DVB-T	Digital Video Broadcasting - Terrestrial
EFM	Ethernet in the First Mile
EIRP	Effective Isotropic Radiated Power
EPON	Ethernet Passive Optical Network
ETSI	European Telecommunications Standards Institute

FEC	Forward Error Correction
FDD	Frequency Division Duplexing
FDM	Frequency Division Multiplexing
FDMA	Frequency Division Multiple Access
FICIX	Finnish Communication and Internet Exchange
FSK	Frequency Shift Keying
FTTB	Fiber-To-The-Building
FTTC	Fiber-To-The-Curb
FTTCab	Fiber-To-The-Cabinet
FTTH	Fiber-To-The-Home
FWA	Fixed Wireless Access
GPRS	General Packet Radio Service
GSM	Global System for Mobile communications
HDSL	High bitrate Digital Subscriber Line
HIPERLAN	High Performance Radio Local Area Network
IEEE	Institute of Electrical and Electronics Engineers
IETF	Internet Engineering Task Force
IP	Internet Protocol
IRR	Internal Rate of Return
ISDN	Integrated Services Digital Network
ISP	Internet Service Provider
ITU	International Telecommunication Union
ITU-R	ITU Radiocommunication sector
ISO	International Organization for Standardization
LAN	Local Area Network

LLC	Logical Link Control (layer)
LMSC	(IEEE 802) LAN MAN Standards Committee
LOS	Line-Of-Sight
MAC	Medium Access Control
MAN	Metropolitan Area Network
MDF	Main Distribution Frame
MDU	Multi-Dwelling Unit
MIMO	Multiple-Input, Multiple-Output
MTBR	Mean Time Between Repairs
MTTR	Mean Time To Repair
MWA	Mobile Wireless Access
MWS	Multimedia Wireless System
NLOS	Non-Line-Of-Sight
NPV	Net Present Value
NRA	National Regulatory Authority
NWA	Nomadic Wireless Access
OA&M	Operations, administration, and maintenance
OAM&P	Operations, administration, maintenance, and provisioning
OFDM	Orthogonal Frequency Division Multiplexing
OFDMA	Orthogonal Frequency Division Multiple Access
OLT	Optical Line Termination
ONT	Optical Network Terminal
ONU	Optical Network Unit
OPEX	Operational Expenditures
OSI	Open Systems Interconnection

PC	Personal Computer
PDH	Plesiochronous Digital Hierarchy
PHY	Physical Layer
PMP	Point-to-multipoint
PON	Passive Optical Network
POTS	Plain Old Telephone Service
PSK	Phase Shift Keying
PSTN	Public Switched Telephone Network
PTP	Point-to-point
QAM	Quadrature Amplitude Modulation
QoS	Quality of Service
QPSK	Quadrature Phase Shift Keying
RLAN	Radio Local Area Network
SDH	Synchronous Digital Hierarchy
SDSL	Single line Digital Subscriber Line
SMP	Significant Market Power
SNMP	Simple Network Management Protocol
SNR	Signal to Noise Ratio
STB	Set Top Box
STC	Space Time Code
TDD	Time Division Duplexing
TDM	Time Division Multiplexing
TDMA	Time Division Multiple Access
TG	Task Group
VDSL	Very high-speed Digital Subscriber Line

VoIP	Voice over IP
WG	Working Group
WLAN	Wireless Local Area Network
WMAN	Wireless Metropolitan Area Network
WLL	Wireless Local Loop

1 Introduction

1.1 Background

The penetration of broadband Internet access in Finland has experienced significant growth during the past few years. In just three years, the number of households subscribing to broadband services has increased from 27.000 to 500.000, and the growth seems to continue. Figure 1.1 shows the broadband penetration, as well as penetrations of personal computers (PCs) and all Internet connections in the Finnish households in 1994-2003.

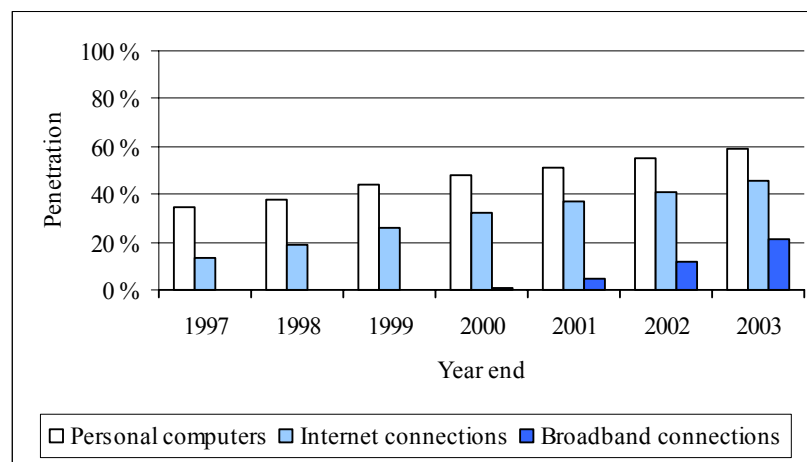

Figure 1.1: Penetration of broadband Internet access in Finnish households 1997-2003 (Statistics Finland 2003a, 2004)

Together with the broadband revolution, the development of wireless technologies has been rapid. Second and third generation mobile networks are bringing Internet services to mobile users at increasingly high speeds. Wireless local area networks (WLANs) have become popular in offices, homes, and public “hotspots”. Broadband wireless Internet access is now feasible both technically and economically.

For quite some time already, fixed wireless access (FWA) networks have been proposed as an alternative technology to deliver broadband services to households and enterprises. Up until now, however, the lack of industry standards has kept the prices of FWA equipment high and required operators to lock in to a single equipment manufacturer. Strict line-of-sight requirements of FWA systems have limited the coverage areas and

decreased the number of potential customers. As such, FWA networks have not been a viable alternative to e.g. digital subscriber line (DSL) or cable modem networks.

Recently published FWA standards from IEEE and ETSI are expected to change the situation. Certified interoperability, lower prices, non-line-of-sight capabilities, and customer-installable end-user terminals have become popular marketing terms in the industry, promising to fix the major problems of earlier generations of FWA systems. Whether or not the technology can live up to the promises is a question requiring careful assessment.

1.2 Purpose and objectives of the thesis

The objective of the thesis is to find out whether the emerging standards-based FWA networks raise opportunities or threats to the current broadband business of operators.

In the thesis, the cost structures of FWA and DSL networks are compared. Market conditions where FWA could become a more economic and cost-effective choice are recognized.

1.3 Scope of the thesis

The thesis is made from a network operator point of view. This means, among other things, that the customers are the service operators in the market, not the actual end-users of the broadband services. Network operator costs related to building and operating the networks are included in the analyses and calculations. Service operator costs related to marketing, customer-care, and value-added services are not considered.

From a technology point of view, the scope of the thesis is limited to 3.5 GHz point-to-multipoint FWA systems based on the IEEE Std 802.16aTM using orthogonal frequency division multiplexing (OFDM).

From a service point of view, the scope of the thesis is limited to broadband data services for residential customers. Circuit-switched telephony services or services for enterprises are not considered.

1.4 Structure of the thesis

The structure of the thesis is illustrated in Figure 1.2.

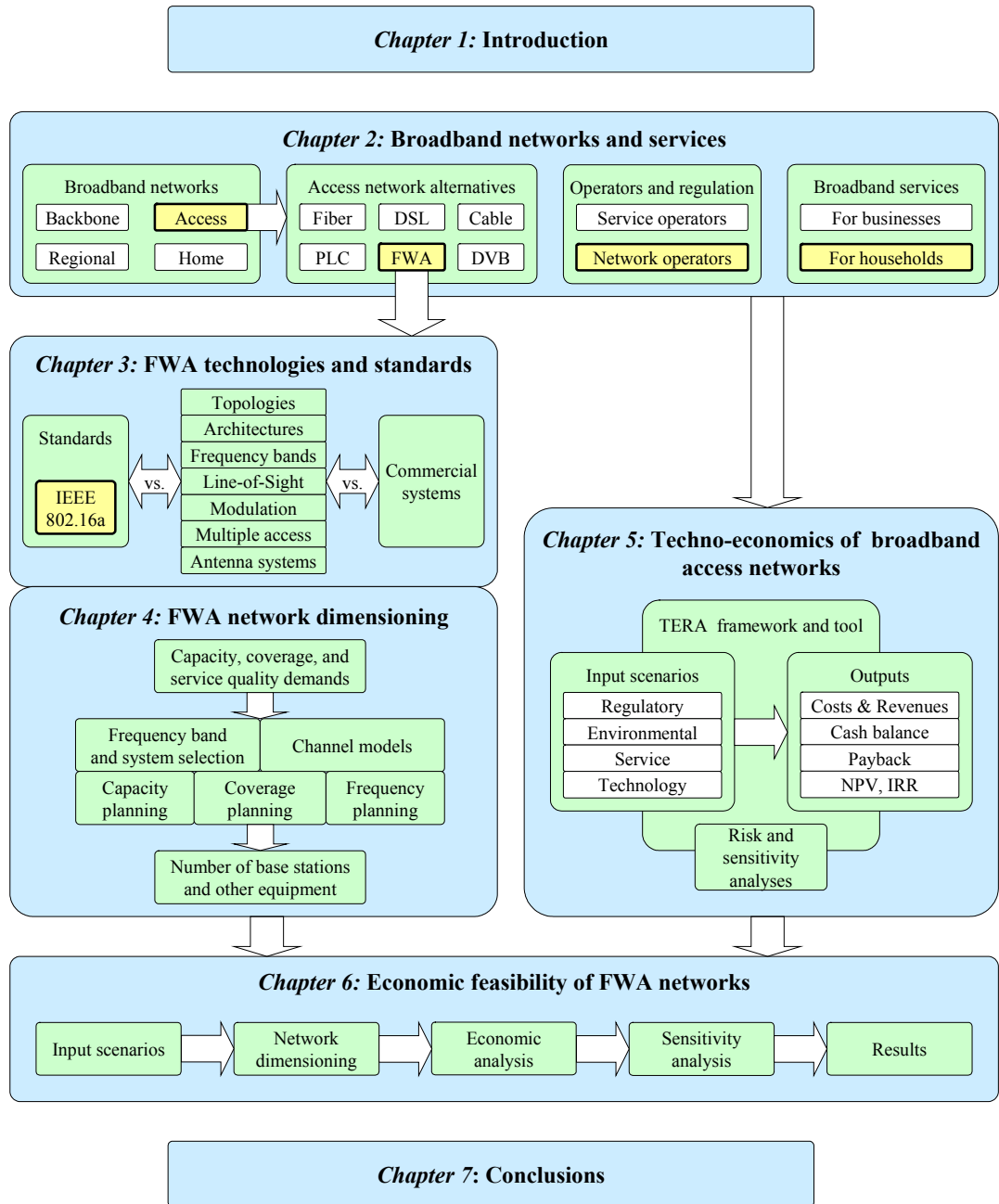

Figure 1.2: Structure of the thesis

After this introduction chapter, an overview of broadband networks and services is given in Chapter 2. Access networks are discussed as an important part of broadband networking, and FWA as one of the many alternative technologies to implement them.

The role of the regulator and the division between network and service operator businesses is also discussed. The chapter ends with a brief overview of broadband services.

In Chapter 3, technologies and techniques related to broadband FWA networks are introduced in more detail, the focus being at the emerging standards-based FWA systems. Architectures of FWA networks are discussed, as well as radio technology related issues such as frequency bands, line-of-sight requirements, multiple access and modulation methods, and antenna systems. Some commercial FWA products are also briefly introduced.

In Chapter 4, the general principles and methods for FWA network dimensioning and planning are introduced. Suitable channel and path loss models as well as general capacity, coverage, and frequency planning principles are introduced. Knowledge on these is required in order to predict reliably the required number of FWA networking equipment for certain service areas.

In Chapter 5, methods and models for economic analyses of broadband access networks are introduced. The required inputs to and outputs from the analyses are discussed, as well as the assessment of the reliability of the results by the means of risk and sensitivity analyses. Furthermore, a software tool (the TERA tool) used to perform the actual calculations is introduced.

Finally, in Chapter 6, the information and methods of the previous chapters are applied to find out the economic feasibility of FWA network deployments in different kind of environments. The analyses are performed for six different environmental scenarios, and for both FWA and ADSL networks.

In Chapter 7, the conclusions, recommendations, and suggestions for further study are given.

1.5 Own contribution

The techno-economic methodology and models used in the thesis are largely based on the results of various research projects carried out in Europe during the past decade (see Chapter 5). In these projects, the techno-economic aspects of broadband access network upgrades have been studied extensively.

Fixed wireless access networks offering non-line-of-sight capabilities are not, however, covered in past studies. These systems, based on the IEEE 802.16 standards, are expected to be competitive against digital subscriber lines and cable modem technologies, and therefore require careful assessment. The use of existing methodology and frameworks makes the analyses straightforward to perform and comparable to past studies.

Author's own contribution in the thesis includes applying existing methodologies, tools, and models in analyzing a new network technology. Technical capabilities and limitations of these new networks differ significantly from the existing ones, requiring proper network planning and dimensioning models to be used. Own contribution is required also in creating the input scenarios for the analyses so that they would resemble the Finnish telecommunications market as closely as possible.

2 Broadband networks and services

The following sections present an introduction to broadband networks and services. The general structure of broadband telecommunication networks is explained, as well as the alternative access network technologies available to the operators and end-users to choose from. The split between service and network operator businesses is also explained. The chapter ends with an introduction to broadband services and applications.

2.1 Broadband networks

A telecommunication network is commonly segmented into three parts: core network, access network, and customer premises network. Among the Finnish telecom operators, the core network is commonly divided further into two components: backbone network and regional network. The backbone network provides interconnections between towns and municipalities, whereas the regional network connects population centers and local districts within a town or municipality. The definitions of the network elements are illustrated in Figure 2.1. (Kääriäinen 2003)

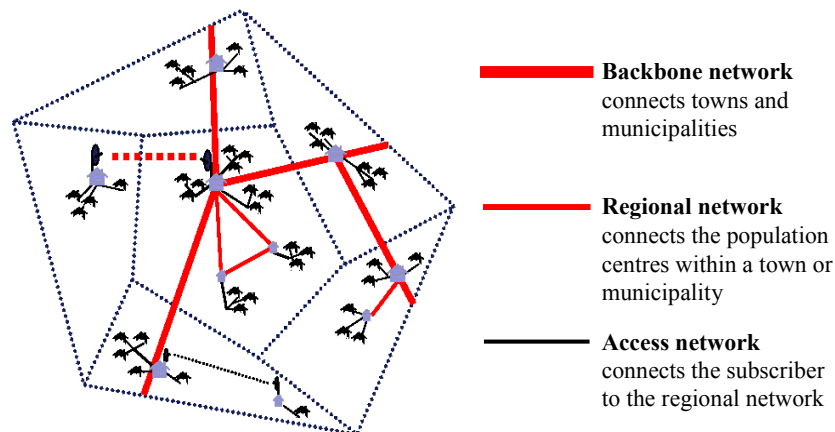

Figure 2.1: Backbone, regional, and access network definitions (Kääriäinen 2003)

The customer premises network can be also further divided into a building network and a home network. The whole broadband network structure, together with common technologies used in each part of the network, is shown in Figure 2.2. As shown, FWA technology is mainly designed as an alternative to e.g. DSL, Ethernet, and cable modem networks in the access network segment. The technology can be used to provide

broadband connections to multi-dwelling units such as apartment houses as well as to individual households.

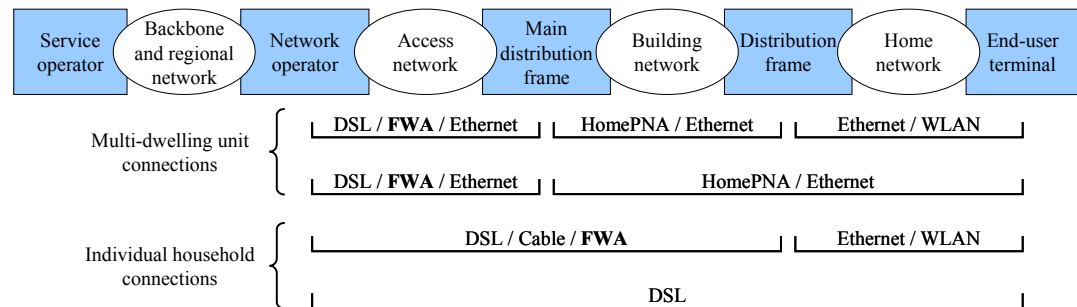

Figure 2.2: Positioning of different technologies in the broadband network structure

2.1.1 Backbone and regional networks

Backbone and regional networks provide connection between access network and central office (service operator's point-of-presence). These networks are mainly based on fiber cables, although radio links are also possible. Finnish service operators interconnect their networks at the Finnish Communication and Internet Exchange (FICIX) exchange points. Connections to the global Internet are arranged by contracting with major international backbone network operators.

The fiber-based backbone network in Finland is extensive, already connecting most of the towns and municipalities. In late 2002, only 20 out of the 448 Finnish municipalities did not have a fiber connection to the backbone network. Furthermore, it is estimated that 85% of the local exchanges and concentrators have a fiber connection. The rest of the exchanges are relatively small, and 98% of the Finnish population is already living within a distance of few kilometers from the fiber backbone. (Kääriäinen 2003)

2.1.2 Access networks

Access networks consist of the so-called "last-mile" connections between the regional network and the subscribers. In the access network, a number of alternative technologies are available, including e.g. digital subscriber lines, cable modem networks, and fixed wireless access networks.

Upgrading the access network to enable broadband services remains as a challenge, also known as the "last mile problem". Despite the high penetration of fiber in the backbone networks, only about 85% of the Finnish households have a possibility to subscribe to

broadband services. According to Ojaniemi & Puumalainen (2002), the main reasons for this have been the moderate demand for the services, the lack of competition in the market, and poor profitability for the operators especially in sparsely populated areas.

2.1.3 Building networks and multi dwelling units

Access network ends at customer premises. In apartment houses, the end point is a distribution frame usually located in the basement. A building network composes of connections between the distribution frame and the apartments, as shown in Figure 2.3.

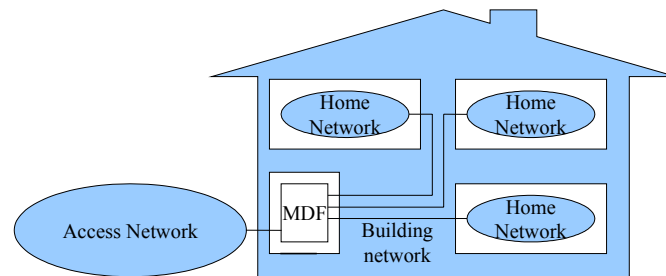

Figure 2.3: A building network between an access network and home networks

Building networks are traditionally used to extend the subscriber lines of the traditional telephone network to the apartments inside a building, using the distribution frame as an interconnection point. DSL connections can be provided for individual apartments in the same way, with no additional equipment required in between.

The building network can also be utilized in another way. Instead of terminating the access network specific broadband connections individually in each apartment, a single broadband access connection can be terminated near the distribution frame and shared between all the apartments using e.g. HomePNA or Ethernet technology inside the building. These multi-dwelling unit (MDU) connections are becoming common in Finland especially in the ADSL market, and all the major players have this kind of a service in their product line.

The concept of MDU connections is important also when considering FWA network deployments because the FWA CPEs (Customer Premises Equipment) have relatively high prices. A single FWA CPE could be shared among the residents in an apartment house in order to achieve cost savings.

2.1.4 Home networks

A home network consists of connections inside an apartment or a single-family house. For example, an Ethernet switch or a WLAN access point can be connected to the building / access network to build a simple home network. In modern houses, a separate distribution frame is often used to provide an interface between the home network and the building / access network.

The technologies used in home networks allow broadband services to be distributed inside the house or apartment. Standard, inexpensive Ethernet and WLAN networks are currently operating at the theoretical data rates of 100 Mbps and 54 Mbps, respectively. Access network is in most cases the bottleneck limiting the available data rates.

2.2 Access network alternatives

The access network constitutes the most extensive and expensive part of the whole telecommunications network. Operators are facing difficult decisions when upgrading their networks to enable new broadband services, and investments in the access network need to be carefully evaluated.

Today, a large variety of access network technologies and architectures are available for the operators to choose from. These include both narrowband and broadband technologies, with and without wires. The selection of the best solution requires understanding of the technical possibilities and limitations of the different alternatives, as well as understanding of the costs resulting from building and operating the networks.

The most important access network alternatives to FWA are introduced below. The comparative strengths and weaknesses of the technologies are also discussed. The focus is on technologies enabling broadband services; narrowband network technologies are out of the scope of this study.

2.2.1 Fiber optics

As discussed earlier, the fiber-based backbone and regional networks are already very extensive in Finland. The fiber network, however, reaches only a small minority of the businesses and residential customers. Although fiber-based access networks are widely accepted as a long-term solution for broadband networking, they are most probably not going to be available for masses in the near future.

The major disadvantage of fiber is its high cost of deployment, resulting from the costly civil works. Fiber cable as such is not very expensive, but the digging, trenching, and repairing of roads and pavements makes the initial investment unbearable in many cases. According to Kääriäinen (2000), extending fiber cable to all businesses and residential customers in Finland would cost about EUR 3.5 billion in investments, excluding operation and maintenance costs and customer terminals.

Optical access networks are usually built using passive optical splitters instead of active components (such as optical wavelength division switches). These passive optical networks (PONs) consist of Optical Line Termination (OLT) equipment at the network operator's premises and a number of Optical Network Units (ONUs) and Optical Network Terminals (ONTs) near or at the end-user premises. Depending on where the PON terminates, the system can be described as a fiber-to-the-home (FTTH), fiber-to-the-building (FTTB), fiber-to-the-curb (FTTC), or fiber-to-the-cabinet (FTTCab) system. Figure 2.4 illustrates this fiber-to-the-x concept.

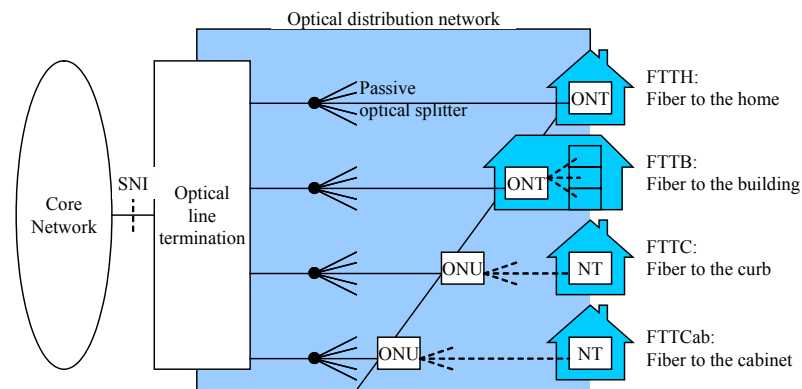

Figure 2.4: The fiber-to-the-x (FTTx) concept (adapted from Maeda et al. 2001)

Although fiber has not yet become the technology of choice in access networks, some operators are already deploying and operating these networks. For example, the Swedish company Bredbandsbolaget provides fiber access for apartment houses in Stockholm, Gothenburg, and Malmö (Bredbandsbolaget 2003).

2.2.2 Digital subscriber lines (DSL)

Digital subscriber line (DSL) technologies use the existing copper line infrastructure of telephone networks in providing broadband access to customers. A number of different DSL technologies and standards are available, including ADSL (Asymmetric DSL),

SDSL (Single-line DSL), HDSL (High bit-rate DSL), G.SHDSL (Symmetric High bit-rate DSL), and VDSL (Very high-speed DSL). The technologies differ by their throughputs and reaches, as shown in Table 2.1.

Table 2.1: Key features of various DSL technologies (Palmén 2003)

Technology	Downstream throughput	Upstream throughput	Maximum distance
ADSL	256 kbps – 8 Mbps	256 - 768 kbps	6 km (2 Mbps)
ADSL G.lite	0 – 1.5 Mbps	0 – 384 kbps	3.5 km
SDSL	2 Mbps	2 Mbps	3.5 km
HDSL	2 Mbps	2 Mbps	3 km
VDSL	14 Mbps – 53 Mbps	1.5 Mbps – 34 Mbps	0.3 km (53 Mbps) 0.7 km (26 Mbps) 1.0 km (14 Mbps)
G.SHDSL	192 kbps – 2.3 Mbps	192 kbps – 2.3 Mbps	4.5 km

ADSL is currently the dominant broadband access technology in Finland and in Europe. Mass production of standard ADSL chipsets and equipment has lowered their prices significantly, giving rise to further success. ADSL provides asymmetric connections with data rates up to 8 Mbps downstream and 768 kbps upstream, fulfilling the customers' bandwidth demands quite well today. A reference model for asymmetric ADSL networks is shown in Figure 2.5.

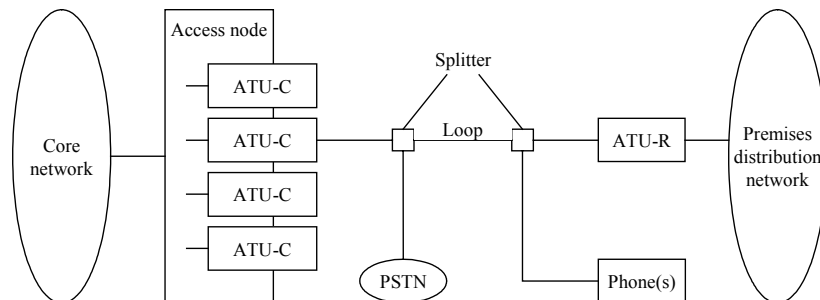

Figure 2.5: ADSL system reference model (adapted from ADSL Forum TR-001 1997)

The access node, also known as the DSL Access Multiplexer (DSLAM), is a central part of the DSL network architecture. It holds a number of ADSL modems (ADSL Transmission Unit, ATU-C) in central office that are then connected to ADSL modems at customer premises (ATU-R). The DSLAM multiplexes the traffic of multiple subscribers into one connection towards the core network. The connection to core network can be based on e.g. ATM or IP transmission.

2.2.3 Cable modem networks

Cable modems can be used to deliver broadband services using the networks of cable television operators. A vast majority of existing cable modem networks are based on the Data-Over-Cable Service Interface Specifications (DOCSIS) of the Cable Television Laboratories (CableLabs), a nonprofit research and development consortium. For Europe, where television systems are different from the U.S., the DOCSIS specifications have been slightly modified and renamed as Euro-DOCSIS specifications.

Figure 2.6 shows the architecture of a data-over-cable network, adapted and simplified from the DOCSIS specifications (CableLabs 2002).

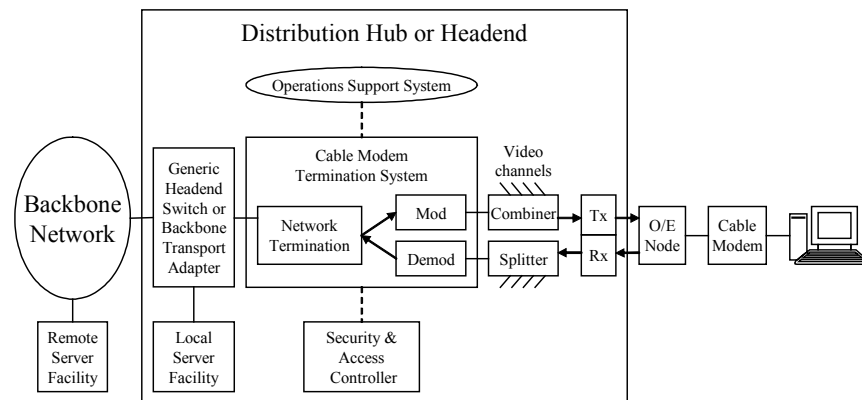

Figure 2.6: Data-over-cable network architecture (adapted from CableLabs 2002)

The main components of a (Euro-)DOCSIS network are the cable modem terminating system (CMTS) residing at the distribution hub or headend of the network operator, and a cable modem located in the customer premises. The CMTS and cable modems modulate and demodulate data to and from a number of channels. The data channels are combined with broadcast video channels and transmitted over a network consisting of both fiber and coaxial cable segments. The network is described as a hybrid fiber-coaxial (HFC) network, and signal transformation between the segments is done in O/E (optical/electrical) nodes.

The capacity of a cable modem network depends on the number of channels the operator has allocated for data transmission, and on the number of segments in the network. Typical capacity of one downstream channel is 38 Mbps, which is shared between all the users in the same network segment. In each segment, the channels can be reused, thus multiplying the network capacity. Cable modem networks are usually

dimensioned for highly asymmetrical traffic, and the upstream bandwidths are lower than in e.g. DSL networks.

In Finland, cable modem networks are available only in the largest cities. Although cable television is already available to more than 1.000.000 households, data services are not usually available in small networks. The investments required for the CMTS systems and the upgrading of the HFC networks for two-way services can be too heavy for the smaller cable television operators.

2.2.4 Ethernet in the first mile (EFM)

Over the last few decades, Ethernet local area networking (LAN) technologies have become dominant in offices and homes, interconnecting computers inside buildings. Recently, use of the technology has been proposed for the access network, as well.

The concept of Ethernet in the First Mile (EFM) has been considered in a number of standardization bodies, including IEEE and DSLForum. In IEEE, standards are being developed by the IEEE 802.3ah EFM Task Force. 802.3ah is defining a number of physical layer specifications, based on both fiber and copper as the transmission medium. The features of the different physical layers are shown in Table 2.2.

Table 2.2: IEEE 802.3ah physical layer specifications (Sources: Diab 2003, Barrass 2003)

Physical layer	Medium type	Throughput	Range
10PASS-T	Copper, short reach	10 Mbps	> 750 m
2BASE-TL	Copper, long reach	2 Mbps	> 2700 m
100BASE-BX10	Optical, point-to-point, simplex	100 Mbps	> 10 km
1000BASE-BX10		1000 Mbps	
100BASE-LX10	Optical, point-to-point, duplex	100 Mbps	> 10 km
1000BASE-LX10		1000 Mbps	
1000BASE-PX10	Optical, point-to-multipoint, simplex (Ethernet PON)	1000 Mbps	> 10 km
1000BASE-PX20			> 20 km

The copper-based EFM physical layers are based on existing VDSL and SHDSL technologies, offering similar throughputs and service ranges. For optical networks, both point-to-point and point-to-multipoint topologies have been defined. The point-to-multipoint EFM networks are also known as Ethernet passive optical networks (EPONs). In addition to the various physical layer specifications, the 802.3ah will also include some OA&M-related definitions and methods to facilitate its use by network operators. (Diab 2003, Barrass 2003).

The proponents of EFM claim that the technology has many advantages over the current access technologies. These include simplicity and cost effectiveness of the global Ethernet standard, the possibility to eliminate costly protocol translations using a single end-to-end protocol, as well as scalability, flexibility and future-proofness of the fiber-based network infrastructure. (EFM Alliance 2002)

2.2.5 Power line communications (PLC)

In addition to the traditional telephone networks, the existing electricity distribution networks offer a transmission medium that reaches almost all households in developed countries. Power line communications (PLC) has been proposed as an alternative for broadband access, but some technical and regulatory problems have to be solved before it is ready for mass market.

Figure 2.7 illustrates a PLC system architecture, as described by Jee et al. (2003).

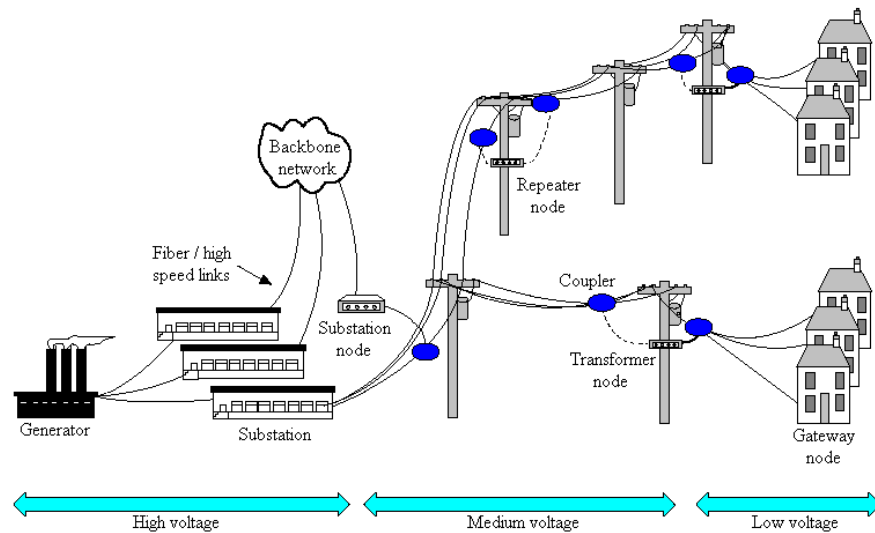

Figure 2.7: PLC system architecture (redrawn from Jee et al. 2003)

The electricity network consists of three levels: high, medium and low voltage distribution networks. In Finland, PLC systems are deployed in the low voltage segments of the network, using fiber to connect the medium-to-low voltage transforming stations to the backbone network. A typical distance from the transformer station to the customer premises ranges between 250 and 450 meters, one station serving about 50-300 customers. Data rates of 4 Mbps are available for one transformer site, state of the art products reaching even 20-45 Mbps. In Finland, PLC systems have

been deployed for testing and limited commercial use in a number of towns, including Vantaa, Turku, Pori, Rauma and Kuopio. (Miettinen 2003)

Varying impedance, considerable noise, and high attenuation of the power lines constitute a rather hostile medium for data transmission (Pavlidou et al. 2003). Another major drawback of the technology is the interference it causes to radio systems.

In addition to access networks, PLC technology can also be used in building and home networks. Products conforming to the HomePlug 1.0 specification enable data rates of 14 Mbps over short distances (HomePlug Powerline Alliance 2003).

2.2.6 Digital video broadcasting (DVB)

Digital video broadcasting (DVB) technology is primarily intended for broadcasting of television programs, but can also be used for broadband data services. DVB systems use a satellite network (DVB-S), terrestrial radio network (DVB-T), or cable television network (DVB-C) for transmissions. The cable network is already served by the DOCSIS-based cable modem systems, but the DVB-S and DVB-T offer a distinctively different way to provide broadband services.

DVB standards are published by the European Telecommunications Standards Institute (ETSI). Figure 2.8 shows a reference model for interactive DVB systems.

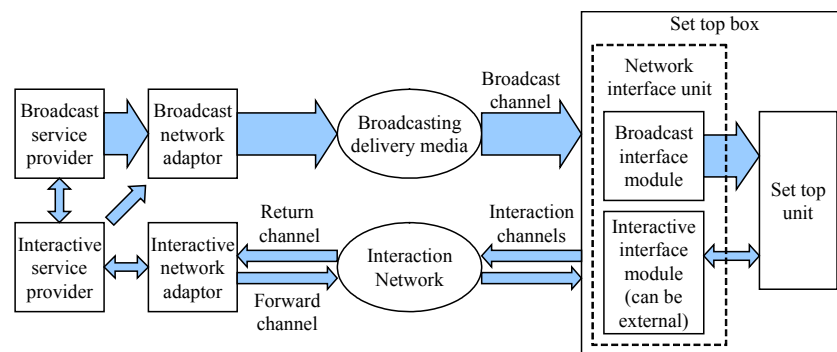

Figure 2.8: Reference model for interactive DVB systems (ETSI ETS 300 801, 1997)

As shown in the model, two separate channels have to be established between the user and the service provider. The broadcast channel is a unidirectional broadband channel delivering video, audio, and data from the service provider to the end user. The interaction channel is a bi-directional channel established for interaction purposes. The return path, or the return channel, is used to make requests from the end user to the

service provider, or to answer questions. The forward interaction path, or the forward channel, is used for communication from the service provider towards the user, and it may also be embedded into the broadcast channel. The user terminal is called a set top box (STB) and it consists of a set top unit and a network interface unit. (ETSI ETS 300 801)

The DVB system is designed for delivering MPEG-2 (Moving Picture Experts Group standard 2) transport streams, which usually contain MPEG-2 video and audio. It is, however, possible to use the system also for data broadcasting. Examples of data broadcasting include downloading software to the set top box, delivering of Internet services over broadcast channels, interactive TV etc. (ETSI EN 301 192)

Broadband services using DVB-T are not currently available for consumers in Finland. Digita has made a technical pilot in their laboratory network (Saikanmäki et al. 2004), but commercial services have not been launched. DVB-S systems, on the other hand, are already used by satellite operators such as Tiscali to deliver broadband services. The TiscaliSat service has been available also in Finland since October 2003. The service requires the use of telephone network or GPRS network as the return channel, meaning that the upstream throughput is limited to about 128 kbps (Tiscali 2003).

2.3 Operators and regulation

2.3.1 Network and service operators

In the telecommunications business, two general types of operators exist: network operators and service operators. According to the Finnish Communications Market Act (MINTC 2003),

***network operator** means an operator that provides a communications network in its ownership or for other reasons in its possession for the purposes of transmitting, distributing or providing messages;*

***network service** means a service provided by a network operator;*

***service operator** means an operator that transmits messages over a communications network in its possession or obtained for use from a network operator or distributes or provides messages in a mass communications network;*

communications service means a service provided by a service operator.

This split to network and service operators is mainly due to actions of the national regulatory authorities (NRAs) of different countries. These actions have been taken in order to break down old monopolies and to improve competition in the telecommunications market.

The majority of Finnish broadband operators are incumbents that used to have a legal monopoly for telephone services in a certain geographical area in Finland. Today, the incumbent operators are doing business both as network operators and service operators. New entrant operators are often acting only as service operators leasing network capacity and resources from the network operators of local incumbents.

One of the goals of telecommunications regulation is that the network operators should offer their networks for all the service operators at a fair price reflecting the actual costs originating from operating the networks. Otherwise, an incumbent operator would be likely to keep its prices so high that it would be uneconomic for any other service operators to do business in the area. The losses made in the own service operator business of the incumbent would naturally be more than compensated by the profits from the network operator business.

This thesis is made from a network operator point of view. This means, among other things, that the actual potential customers are all the service operators in the market, not the end-users of the broadband services.

2.3.2 Significant market power

The concept of significant market power (SMP) plays a major role in the telecommunication regulation. On the basis of a market analysis, the Finnish Communications Regulatory Authority (FICORA) may declare a telecommunications operator to be an operator with SMP in a particular market. The SMP operators may be (and usually are) obliged to relinquish access rights to their networks, antenna sites, and equipment facilities, and to interconnect their network with other operators. The obligation for accounting separation requires the operators to separate the network operator and the service operator functions, at least in the accounting level. The SMP operators are also obliged to publish the delivery terms and tariff information related to

the leasing obligations, access rights, and interconnection. Operators violating these obligations may be ordered to pay substantial penalties. (MINTC 2003)

2.3.3 DSL network services

At the moment, DSL networks can be seen as the most important competitor to FWA networks. When an operator wants to expand its business to new geographical areas, a choice has to be made whether to build a new FWA network or to offer DSL services as a service operator utilizing the local incumbent's network infrastructure. This problem is assessed in the economic analysis in Chapter 6.

DSL service operators can choose between a number of different network services provided by the local incumbents. These include full unbundling of subscriber lines, shared access, bitstream access, and simple resale services, as explained in the following (Commission of the European Communities 2002).

*In the case of **full unbundling**, the copper pair is rented to a third party for its exclusive use.*

*In the case of **shared access**, the incumbent continues to provide telephony service, while the new entrant delivers high-speed data services over the same local loop.*

***Bitstream access** refers to the situation where the incumbent installs a high-speed access link to the customer premises and then makes this link available to third parties, to enable them to provide high-speed services to customers. The incumbent may also provide transmission services to its competitors, to carry traffic to a "higher" level in the network hierarchy where new entrants may already have a broadband point of presence.*

***Simple resale** occurs where the new entrant receives and sells on to end-users - with no possibility of value-added features to the DSL part of the service - a product that is commercially similar to the DSL product provided by the incumbent to its own retail customers, irrespective of the ISP service that may be packaged with it.*

Full unbundling and shared access services are commonly available from the Finnish network operators, and also the bitstream access services are usually available. Some operators have also published the service tariffs on their web pages.

2.4 Broadband services and applications

2.4.1 Broadband definition

In the telecommunications industry, the term broadband is used very loosely, and has many different interpretations. First of all, the "breadth" of a broadband connection varies significantly depending on the source. In the context of broadband integrated services digital networks (B-ISDN), the International Telecommunications Union (ITU) defines broadband as "*a service or system requiring transmission channels capable of supporting rates greater than the primary rate*", the primary rate being 2.048 Mbps in Europe (ITU-T Recommendation I.113). Other values commonly used as the lowest limit for broadband services are 256 kbps and 512 kbps.

The consumers, however, do not perceive a broadband service merely in terms of higher throughput. Of course, the throughput has to be significantly higher than the 56 kbps achievable with dial-up modems, but there are also other benefits associated with the service. A definite advantage is that charging is usually based on a fixed, monthly fee, making the service safe to use without concerns about it getting too costly. Furthermore, the broadband service is usually "always-on" and can be used instantly without a need for dial-up procedures.

In the thesis, the term broadband is used to describe a service that is always on, has a fixed monthly tariff, and offers data rates of at least 256 kbps both upstream and downstream. This is in accordance with the offerings of most Finnish broadband operators today.

2.4.2 Network, communications, and value-added services

As discussed earlier, the telecommunications services can be divided into network services and communications services. Network services include e.g. the leasing of access rights to networks, antenna sites, and equipment facilities, and they are usually invisible to the end-users. End-users subscribe to communications services, which in the case of broadband subscription mean Internet connectivity with a certain throughput.

In addition to the actual broadband network connection, a complete broadband service offering usually includes a number of value-added services. These include e.g. electronic mail boxes, web page hosting, and security services. IP telephony is another service emerging at the residential market that could be seen both as a communications service or value-added service.

2.4.3 Applications and their requirements

Technical requirements for broadband networks depend on the applications and services to be used. When designing a network, a decision has to be made on the applications and services to be enabled in the network, a decision largely affected by the willingness of the customers to pay for these services. Since the network investments are expensive and their lifetime spans many years, the future needs of the customers must also be taken into account.

Although quality of service (QoS) is usually brought out when discussing real-time applications such as video conferencing or IP telephony, all applications have some QoS requirements for the network. The most important properties affecting the perceived QoS of the end-user are the throughput, delay, delay variation, and error rate of the IP traffic flows. Throughput and relative QoS level requirements of different applications are illustrated in Figure 2.9.

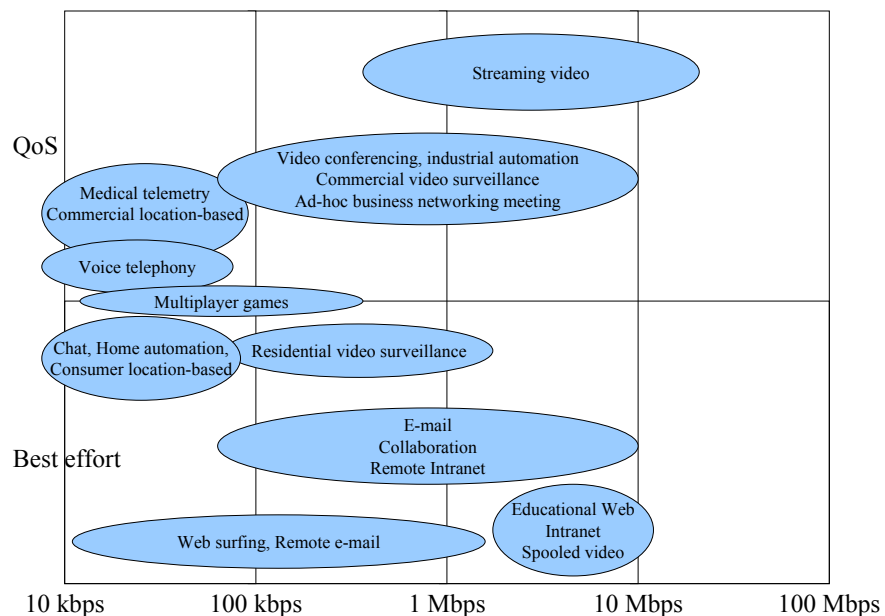

Figure 2.9: Throughput and QoS requirements of some applications (ETSI TR 101 856)

2.5 Chapter summary

Broadband network infrastructure consists of several segments. As new services requiring broadband connectivity are introduced, access network is the segment that first becomes a bottleneck. Access network is also the most expensive segment to build and upgrade, which makes the choice of optimal technology extremely important.

FWA networks are an alternative access network technology to ADSL and cable modem technologies. Other possibilities include fiber, PLC, EFM, and DVB-based systems. The main features of these are summarized in Table 2.3.

Table 2.3: Comparison of wired access network technologies

Technology	Medium	Typical data rates	Range from a central node	Advantages	Disadvantages
Fiber optics	Optical fiber	Tens of Mbps per subscriber	Tens of kilometers	Future-proof, unlimited data rates	High cost of civil works
DSL	Telephone lines (copper)	256 kbps - 53 Mbps	< 0.5 - 5 km	Existing copper network infrastructure, Low equipment cost	Limited range, especially on higher data rates
Cable modem systems	Coaxial cable	38 Mbps per network segment, 0 – 2 Mbps per subscriber	Tens of kilometers	Existing cable television network, Low equipment cost	Shared transmission medium, available only to network owners
Ethernet in the first mile	Copper / Fiber	2-10 Mbps / 100-1000 Mbps	Tens of kilometers (fiber), 3 kilometers (copper)	Same as in fiber / DSL networks	Same as in fiber / DSL networks
PLC systems	Power lines (copper)	0 – 1 Mbps per subscriber	< 500 m	Existing power line infrastructure	Available only to energy companies, interference to radio systems
DVB systems	Air (satellites and terrestrial radio)	0 - 2 Mbps per subscriber	Tens / thousands of kilometers	Available almost everywhere	Low-speed return channel, high latency

Each of the technologies has its own strengths and weaknesses, both from the technological and economic perspective. The operator has to be well aware of these in order to find the most cost-effective solutions for its own access networks and to be able to assess the strength of competitive network technologies. In the following chapter, fixed wireless access networks are introduced in more detail as another alternative to solve the last-mile problem.

3 FWA technologies and standards

The International Telecommunication Union (ITU) defines *wireless access* as end-user radio connection(s) to core networks. Examples of wireless access include *fixed wireless access* (FWA), *mobile wireless access* (MWA), and *nomadic wireless access* (NWA). FWA is defined as a wireless access application in which the location of the end-user termination and the network access point to be connected to the end-user are fixed. In MWA, the location of the end-user termination is mobile, while in NWA the terminal may move between different places but must be stationary while in use. (ITU-R F.1399-1)

It should be noted that the ITU categorization applies to wireless applications, not to wireless technologies or standards. For example, WLAN technology is usually used in portable terminals such as laptops, making it a good fit to the NWA category. However, WLAN radios have been integrated also in mobile devices such as PDAs (Personal Digital Assistant) and mobile phones, and the networks offer handovers between access points. Furthermore, the technology can be used in fixed applications, e.g. to bridge networks in separate buildings with fixed radio links or to provide residential customers with broadband access to Internet. In other words, WLAN technology can be used in FWA, NWA, and MWA applications.

In the same way, the FWA category includes in practice all wireless technologies, as long as the locations of the terminals are fixed. In this thesis, FWA technologies are analyzed as a possible means to provide broadband services to residential customers living in a relatively broad area such as a town or a municipality. Therefore, special requirements are set regarding the throughput and coverage of the networks. Narrowband and/or short-range radio technologies are out of the scope of this thesis.

In the following sections, technologies and techniques related to broadband FWA networks are introduced. The focus of the chapter is put on the emerging FWA standards from IEEE and ETSI. Available frequency bands for FWA systems are then discussed. Further on, topologies and architectures of FWA networks are discussed, as well as radio technology related issues such as multiple access and modulation methods and antenna systems. The chapter ends with an overview of some commercial FWA products found in the market.

3.1 FWA standards and interoperability

Standardization plays a major role in the acceptance and spreading of all networking technologies. Up until now, the FWA industry has not had a standard that would allow interoperability between equipment from different vendors. Instead, all the systems in the market have been proprietary, leading to high prices and customer lock-in to one manufacturer.

FWA standards published recently by IEEE and ETSI improve the business prospects of FWA networks significantly. Several manufacturers, including major players such as Intel, have announced their support for the standards. An organization named the WiMAX (Worldwide Interoperability for Microwave Access) Forum has been established to test, certify, and promote interoperable products from different manufacturers.

The focus in this thesis is on these new, standards-based broadband FWA technologies. The standards and the organizations behind them are introduced in the following.

3.1.1 IEEE 802 LMSC

The IEEE 802 LAN/MAN Standards Committee (LMSC) develops LAN and MAN standards, mainly for the lowest two layers of the Open Systems Interconnection (OSI) reference model, i.e. the physical layer and the data link layer. Figure 3.1 shows the IEEE 802 reference model and its relation to the OSI reference model.

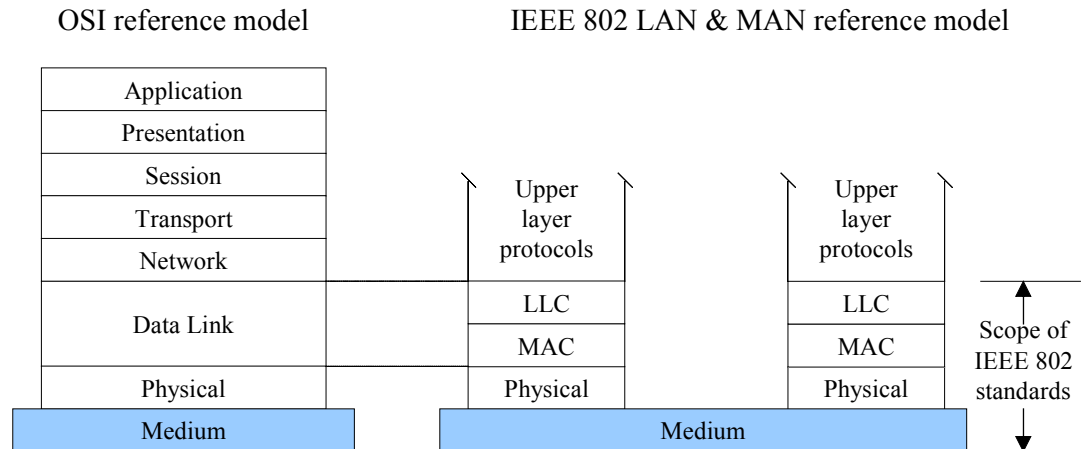

Figure 3.1: IEEE 802 LAN & MAN reference model (Adapted from: IEEE Std 802-2001)

In the IEEE 802 standards the Data Link layer is structured as two sublayers, with the Logical Link Control (LLC) sublayer operating over a Medium Access Control (MAC) sublayer. The LLC layer is common for all the IEEE 802 standards and specified in the IEEE 802.2 standard. (IEEE Std 802-2001)

Most of the work in the 802 LMSC is conducted in a number of Working Groups (WGs). Each WG typically develops a common MAC layer specification and one or more PHY layer specifications. New, higher throughput PHY layers are often added in the process of time as technology advances. The most relevant WGs from the point of view of FWA networks are the 802.11 and 802.16.

IEEE 802.11 Wireless Local Area Networks

The IEEE 802.11 WG defines standards for wireless LANs. Wireless LANs are primarily used as an extension to, or replacement for, traditional wired LANs inside buildings. The reason wireless LANs are discussed here is that they can be and have also been used to provide Internet services to residential customers. For example, the Finnish company Radionet (2003) has delivered citywide outdoor WLAN networks to many Finnish cities. The main driver of WLAN-based last-mile access networks is the low cost of the radio equipment that results from the success of the technology in enterprise and home markets.

The IEEE 802.11 WG published its first standard in 1997, and since then several new Task Groups (TGs) have been established to create new PHY layer specifications or to enhance the common MAC layer specification.

The original 802.11 standard included three alternative PHY layer specifications, with maximum data rates of 2 Mbps. These are not used in any commercial products anymore. Instead, the equipment manufacturers have adopted at least one of three higher throughput PHYs: 802.11b, 802.11a, or 802.11g, with maximum data rates of 11 – 54 Mbps.

The 802.11 MAC layer specification is based on CSMA/CA (Carrier Sense Multiple Access with Collision Avoidance) multiple access scheme. The medium access is contention-based and connectionless, and does not support any QoS mechanisms or traffic differentiation. Also the security mechanisms of the original MAC layer are

flawed. The QoS and security mechanisms have been enhanced by 802.11e and 802.11i working groups, respectively.

(IEEE 802.11 2003)

IEEE 802.16 Broadband Wireless Access

The IEEE 802.16 WG is the most important forum from the point of view of fixed wireless access network standardization. The working group has published standards for FWA networks operating on a wide range of frequency bands, both licensed and unlicensed.

The original IEEE Std 802.16-2001™ specifies an air interface, including MAC and PHY layers, of fixed point-to-multipoint broadband wireless access systems. The standard includes a MAC layer specification that is capable of supporting multiple PHY layer specifications. The standard also includes a PHY layer specification for systems operating at 10-66 GHz.

The IEEE Std 802.16a-2003™ expands the scope of the base standard to address frequencies between 2 and 11 GHz. The standard includes four new PHY layer specifications and several enhancements to the MAC layer. The PHY layer alternatives include single carrier, OFDM, and OFDMA-based specifications. An OFDM PHY layer is also specified for unlicensed frequency bands.

The IEEE 802.16 standards have gained support from the FWA equipment manufacturers. Many manufacturers have announced products conforming to the OFDM-based version of the 802.16a standard that will be certified for interoperability by the WiMAX Forum. Intel has been an active proponent of the technology and announced to begin manufacturing the 802.16a chipsets. Products conforming to the standard are expected to hit the market in the late 2004.

3.1.2 ETSI BRAN

The standardization project for Broadband Radio Access Networks (BRAN) was established by ETSI in 1997. As the name implies, the project is preparing standards for broadband radio access networks, including WLANs and FWA networks.

ETSI BRAN is currently working on three different standard areas: HIPERLAN/2, HIPERACCESS, and HIPERMAN. The standards address the physical (PHY) layer and the data link control (DLC) layer of the ISO OSI model. Interworking with existing wired networks (e.g. ATM, IP, and 3G) is ensured by technology-specific convergence layer specifications. (ETSI BRAN 2003)

HIPERLAN/2 is a wireless LAN standard operating at the 5 GHz frequency bands, similarly to the 802.11a standard. In fact, the OFDM-based physical layer specifications of the two standards are almost identical, due to co-operation between IEEE and ETSI. In addition to Ethernet LANs, HIPERLAN/2 is designed to provide high-speed access to a variety of networks including 3G mobile core networks and ATM networks.

The HIPERACCESS standard is intended for FWA networks operating at frequencies above 11 GHz, similarly to the IEEE 802.16-2001 standard. Especially, it will be optimized for the 40.5 – 43.5 GHz band.

The HIPERMAN standard is intended for FWA networks operating below 11 GHz. The standard allows interoperability with the OFDM-based version of the IEEE 802.16a standard, due to close co-operation between the standardization bodies. The standard supports ATM and IP traffic, point-to-multipoint and mesh topologies, and non-line-of-sight operation.

(ETSI BRAN 2003)

3.1.3 *WiMAX Forum*

The WiMAX Forum is a non-profit organization that was formed in 2001 to *"promote the wide-scale deployments of fixed broadband wireless access networks operating above 2 GHz by using a global standard and certifying the interoperability of products and technologies"*. (WiMAX Forum 2002)

WiMAX Forum intends to enable interoperability between equipment manufacturers that base their products on the IEEE 802.16 and ETSI HIPERMAN standards. It has developed system profiles that specify which features of the standards are mandatory and optional for the equipment manufacturers to implement, allowing them to build interoperable systems. In addition to the system profiles, WiMAX Forum is developing conformance and test specifications and intends to select an independent laboratory for

conformance testing of the products. Systems conforming to the specifications will be awarded a "WiMAX™ Certified" label, similarly to the "Wi-Fi Certified" label given to WLAN products based on the 802.11 standards. (WiMAX Forum 2002, 2003)

As a summary, Table 3.1 shows the main features of the different WLAN and FWA standards.

Table 3.1: Standards for WLAN and FWA networks

Standard	Frequency	Max. Data Rate	Physical layer	Multiple Access
IEEE 802.11	2.4 GHz	2 Mbps	DSSS, FHSS, Infrared	CSMA/CA
IEEE 802.11b	2.4 GHz	11 Mbps	DSSS/CCK	CSMA/CA
IEEE 802.11a	5 GHz	54 Mbps	OFDM	CSMA/CA
IEEE 802.11g	2.4 GHz	54 Mbps	OFDM	CSMA/CA
IEEE 802.16	11-60 GHz	> 70 Mbps	Single carrier	TDMA
IEEE 802.16a	2-11 GHz	25 Mbps (OFDM, 7 MHz)	Single carrier, OFDM, OFDMA	TDMA
ETSI HIPERLAN/2	5 GHz	54 Mbps	OFDM	TDMA
ETSI HIPERACCESS	11-60 GHz	> 70 Mbps	Single carrier	TDMA
ETSI HIPERMAN	2-11 GHz	25 Mbps (7 MHz)	OFDM	TDMA

In the thesis, the focus is on WiMAX-certified systems conforming to the IEEE 802.16a standard.

3.2 FWA frequency bands

Table 3.2 shows the frequency bands available for FWA applications in Finland (Ficora 2004). The table also shows whether the bands are licensed or unlicensed.

Table 3.2: Available frequency bands for FWA systems in Finland (Ficora 2004)

Name	Frequency band	Bandwidth	Type
2.4 GHz ISM band	2.400 – 2.4835 GHz	83.5 MHz	Unlicensed
3.5 GHz FWA band	3.410 – 3.600 GHz	190 MHz	Licensed
5 GHz RLAN band	5.470 – 5.725 GHz	255 MHz	Unlicensed
10.5 GHz FWA band	10.150 – 10.300 GHz, 10.500 – 10.650 GHz	2 x 150 MHz	Licensed
26 GHz FWA band	24.577 – 25.417 GHz, 25.585 – 26.425 GHz	2 x 840 MHz	Licensed

The 2.4 GHz Industrial, Scientific, and Medical (ISM) band is unlicensed, and available almost worldwide. The frequency band is currently used by WLAN and Bluetooth systems as well as cordless phones and microwave ovens, among others. Any radio device can use the band as long as the radiated power stays below a certain limit. FWA

network systems using the 2.4 GHz frequency band are usually based on WLAN standards.

The 5 GHz radio LAN (RLAN) band actually consists of two frequency bands: 5.150 GHz – 5.350 GHz and 5.470 GHz – 5.725 GHz. The bands are allocated for RLANs, which is the ITU term for WLAN networks using radio transmission. The frequency bands are unlicensed, but can only be used by RLAN devices. Only the upper RLAN band is intended for outdoor usage, limiting the total bandwidth available to the FWA networks to 255 MHz, which is still considerably more than the 83.5 MHz of the 2.4 GHz ISM band. This allows more radio channels to be used in the same geographical area, which increases the potential capacity of the network, decreases interference, and makes network planning easier. The transmission paths in the network are, however, shorter due to the higher frequencies applied.

The 3.5 GHz, 10.5 GHz, and 26 GHz frequency bands are allocated to FWA systems in Europe. The 3.5 GHz and 10.5 GHz bands are intended for point-to-multipoint applications only, while in the 26 GHz band traditional point-to-point fixed radio links can be deployed as well. The frequency bands are licensed, and an annual spectrum fee is charged for the use of the bands. The charged amount depends on the frequency range, the frequency band and the geographical coverage area of the network. The FWA license holders are shown in Appendix A.1, and an example of a spectrum fee calculation is given in Appendix A.2.

3.3 Network topologies

FWA network topologies can be grouped into three main categories: point-to-point, point-to-multipoint, and mesh networks. Point-to-point (PTP) FWA networks consist of one or more fixed PTP links employing highly directional antennas at both ends of the link. In point-to-multipoint (PMP) topology, the network consists of a number of base stations, each one connected to multiple end-user terminals. This offers cost savings compared to multiple PTP links, as the radio equipment at the base station site can be used to serve multiple customers.

In a mesh topology, the end-user terminals act also as routers for each other's traffic. Base stations are also needed to provide connections to the core network. Mesh networks offer a way to improve the coverage of a wireless access network as each new

subscriber can be effectively seen as a new base station serving subscribers nearby. At the same time, however, the capacity of some links in the network might be strained. The end-user terminals are also more complex, because of the routing functionality needed. Currently, there are not many mesh-based FWA systems in the market.

Actual FWA networks often use combinations of the different topologies. For example, it is common to use PTP links as a backbone to multiple PMP base stations. A combination of different radio technologies is also possible. For example, 3.5 GHz FWA systems can be used as a backhaul for 2.4 GHz WLAN access points that provide the connections to the user. This kind of architecture has been used in Finland e.g. by Vantaan Energia (2003) in its wireless access network.

In the IEEE 802.16 standards, both PMP and mesh topologies have been specified. A vast majority of FWA systems found in the market today are PMP systems. Some mesh-based systems have also been introduced, but PMP systems are likely to be dominant also in the near future. PMP systems are hence also in the focus of this thesis. Figure 3.2 shows an example of a possible point-to-multipoint network deployment.

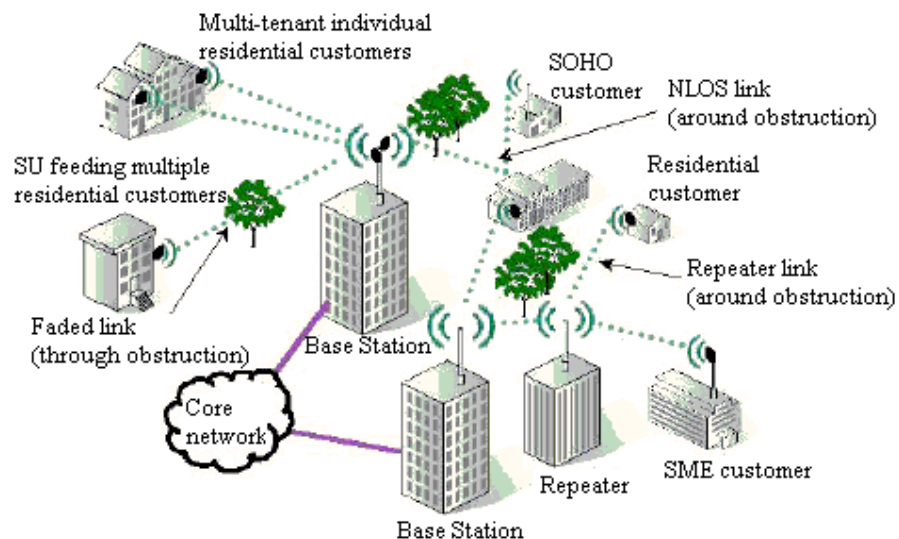

Figure 3.2: Example of a point-to-multipoint network deployment (ETSI TR 101 856)

3.4 Point-to-multipoint network architecture

An example of a typical point-to-multipoint FWA network architecture is shown in Figure 3.3. (Ibe 2002, p.7)

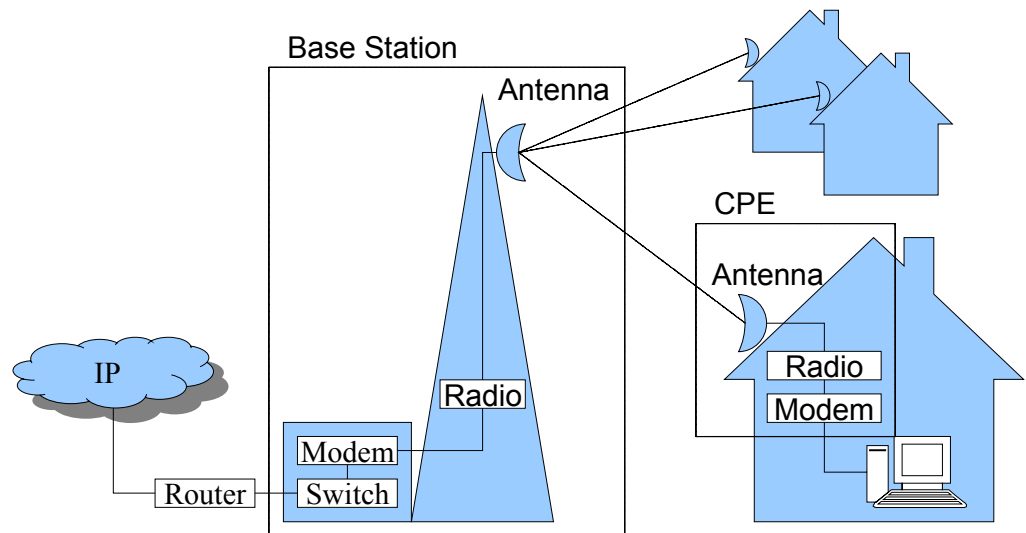

Figure 3.3: Example of a fixed wireless access network architecture (Ibe 2002, p. 7)

As shown in the figure, a point-to-multipoint FWA network is essentially a sectorized network consisting of two principal components: a base station and customer premises equipment (CPE).

The base station consists of one or more radio transceivers, each of which connects to several CPEs inside a sectorized area. The radio modems are connected to a multiplexer, such as a switch, which aggregates the traffic from different sectors and forwards it to a router that provides the connection to the service provider's IP network.

The CPE consists of three main parts: a modem, a radio, and an antenna. The modem provides an interface between the customer's network and the FWA network, while the radio provides an interface between the modem and the antenna. The three units can be separate, or partly or fully integrated into one or two pieces of equipment. (Ibe 2002, p.6-8)

3.5 Line-of-sight in point-to-multipoint networks

The profitability of a FWA network installation depends among other things on the number of subscribers that can be reached by the system. The available subscriber base is strongly affected by the ability of the system to connect to buildings that do not have a direct line-of-sight connection to the base station. Accordingly, point-to-multipoint FWA networks are often divided into two categories: line-of-sight (LOS) and non-line-

of sight (NLOS) systems. Depending on the reference, however, the use of these terms varies considerably.

The NLOS capability has become some sort of a hype term in the industry, and almost every system manufacturer in the market claims their products to be NLOS capable. The NLOS term has also different meanings among different players in the industry. Table 3.3 clarifies the different “flavors” of line-of-sight and non-line-of-sight systems.

Table 3.3: Point-to-multipoint FWA network categorization

System category	Line-of-sight systems		Non-line-of-sight systems	
Subcategory	Line-of-sight	Near-line-of-sight	Outdoor non-line-of-sight	Indoor non-line-of-sight
Radio path	Direct, no obstructions	Direct, obstructed by e.g. trees	Reflected, no line-of-sight components	Reflected, no line-of-sight components
CPE antenna	Highly directional, installed outside the building	Highly directional, installed outside the building	Directional, installed outside the building	Omni-directional, integrated with the CPE, installed inside the building by the user

NLOS capable networks have major advantages over LOS networks. Firstly, as the coverage area of FWA base stations is better, the potential subscriber base is also larger. The marketing and provisioning of FWA subscriptions is also easier, as the network can be promised to cover all the locations in a certain area. In the case of indoor NLOS networks, another major improvement are user installable CPEs.

From the operator’s point of view, user installable CPEs are favorable because professional technicians are not needed to install the equipment, leading to lower provisioning costs. Furthermore, as the CPEs are installed indoors, they do not have to be designed to survive heavy rain or extreme temperatures. The omni-directional nature of the CPE antennas yields yet another benefit, namely portability. Since the CPE antenna does not have to be fixed or directed, it is possible for the customer to use the broadband connection at any place inside the network's reach. The signal range of a NLOS network with the CPEs installed indoors is, however, significantly smaller than in systems using directional antennas installed outdoors. Because of this, base stations have to be deployed more densely.

In the thesis, the focus is on systems capable to non-line-of-sight operation. The pros and cons of NLOS networks are studied further in the economic analysis in Chapter 6.

3.6 Modulation and coding

Many of the advances in communications technology in the recent years have been in the ways that the transmitted signals are coded, modulated, demodulated, decoded, and otherwise structured to enable reliable communications and maximize the efficient use of the spectrum (Anderson 2003, p. 235). The modulation and coding methods introduced in this section are those seen as the most important for digital FWA networks.

A transmitted signal has three fundamental characteristics, frequency, amplitude, and phase, which all can be changed individually or in combination in response to the information that is to be transmitted. The fundamental modulation types can therefore be grouped as Amplitude Shift Keying (ASK), Frequency Shift Keying (FSK), and Phase Shift Keying (PSK). A variety of modulation methods can be derived by combining these. As the number of discrete amplitude levels, frequencies, or phase states increases, more information bits can be conveyed with one symbol. At the same time, however, noise, interference, and channel impairments make it increasingly difficult to detect which symbol has been transmitted. This trade-off problem can often be solved automatically by the system, if it applies an adaptive modulation, or link adaptation mechanism. (Anderson 2003, p. 236-237)

FWA systems use either single-carrier or multicarrier modulation. In the single-carrier modulation, data is transmitted using a single carrier wave that is modulated in accordance to the data stream. In the multicarrier modulation, the data stream is divided in the transmitting end to multiple parallel data streams, each of which modulates its own subcarrier. In the receiving end, the subcarriers are demodulated and the data streams combined.

3.6.1 *Single-carrier modulation methods*

Binary phase shift keying (BPSK) and quadrature phase shift keying (QPSK) are two of the most simple and robust single-carrier modulation methods. BPSK switches between two phase states to convey the bit pattern, while QPSK switches between four states. The number of bits per transmitted symbol is therefore one (0 or 1) for BPSK and two (00, 01, 10, or 11) for QPSK.

In order to increase data rate, modulation methods with more information bits per symbol are needed. The family of modulation types known as quadrature amplitude modulation (QAM) is often used to achieve these higher rates. In QAM modulation, both the amplitude and the phase of the symbol are altered. The number of constellation points defines the name of the modulation method; e.g. 16-QAM and 64-QAM are commonly used in FWA systems. For instance, when applying 64-QAM, six bits can be transmitted per symbol ($2^6 = 64$).

Many FWA systems use adaptive modulation, meaning that the system will automatically select the modulation and coding scheme according to the channel conditions. For example, a system that normally uses 16-QAM might revert to QPSK modulation under heavy rain to maintain the communication link. Adaptive modulation mechanisms can also be used to improve the overall capacity of the FWA system, by allowing different modulation schemes to be used with different subscribers. For example, some CPEs located near the base station could be using 64-QAM while other CPEs farther away use 16-QAM or QPSK.

(Anderson 2003, p. 236-241)

3.6.2 *Multicarrier modulation using OFDM*

OFDM (Orthogonal Frequency Division Multiplexing) is an example of multicarrier modulation methods. In OFDM, a number of relatively low bandwidth subcarriers are modulated, using e.g. QAM modulation on each. The composite data rate of the subcarriers is comparable to the data rate of a single carrier system using the same modulation at a higher rate in the same channel bandwidth. Since the symbol duration is longer, the susceptibility to intersymbol interference due to multipath time dispersion is lower. Also, frequency selective fading affects only a few of the subcarriers, and the bit errors on those can be often corrected using coding. (Anderson 2003, p. 241-242).

For the reasons mentioned above, OFDM has become an important option for FWA systems, especially for non-line-of-sight point-to-multipoint systems (Anderson 2003, p. 244). New wireless LAN standards are already using OFDM with 64 subcarriers and for FWA systems the IEEE standard 802.16a defines an OFDM physical layer using 256 subcarriers. OFDM technology has also been proposed as a possible technology for next generation mobile systems.

3.6.3 Coding methods

Coding is used to add redundancy to the transmitted signal in order to allow errors to be detected in the data reception. Detected errors can then be corrected at the receiving end using forward error correction (FEC), or the data block can be requested to be retransmitted using an automatic retransmission request (ARQ) mechanism. FEC is preferable to ARQ because retransmissions decrease the throughput of the system and cause delays often unsuitable for real-time applications such as voice or video conversations.

Coding methods commonly used in FWA systems include block codes, convolutional codes, and space-time codes. Block and convolutional codes add redundancy in the time domain by adding code bits to the time sequence of information bits. In block codes, a block of k data symbols is encoded into a block of n code symbols. The code is referred to as (n, k) code, and the code rate is given by the ratio k / n . Convolutional codes can be characterized in the same way. They differ from block codes in that the encoder output is a function of not only the present block of k information symbols but also of the previous symbols.

Space-time codes (STCs) make use of the uncorrelated channel responses that exist when using multiple transmit and receive antenna elements. They are used together with multiple-input, multiple-output (MIMO) antenna systems, and use both the time and space domains to send redundant information to the receiver. In FWA systems, the use of OFDM with MIMO antenna systems and STCs is seen as an enabler to non-line-of-sight capabilities.

(Anderson 2003, p. 262-273)

3.7 Multiple access and duplexing

In multiple access radio systems transmission medium is shared among all the terminals. In order to avoid overlapping transmissions and interference, the access to the medium has to be controlled in some way. Multiple access and duplexing methods are needed to allow many users to share a finite amount of radio spectrum simultaneously.

3.7.1 *Duplexing methods*

Duplexing is a method used to accomplish two-way communication between two terminals. Two methods are commonly used in FWA systems: time division duplexing (TDD) and frequency division duplexing (FDD). The choice of the duplexing method is generally independent of the multiple access and modulation methods.

In FDD separate frequencies are assigned to upstream and downstream communication, whereas TDD uses the same frequency channel for both upstream and downstream communication. In TDD the time a system uses for subsequent upstream and downstream transmissions can be adjusted to accommodate to asymmetrical traffic.

(Anderson 2003, p. 310-311)

3.7.2 *Multiple access methods*

Multiple access methods are used to separate the users in a transmission channel. The most common multiple access methods used in FWA systems include frequency division multiple access (FDMA), time division multiple access (TDMA), code division multiple access (CDMA), orthogonal frequency division multiple access (OFDMA), and carrier sense multiple access (CSMA).

In IEEE 802.16 standards, several duplexing and multiple access methods have been specified. In the thesis, the focus is on the systems using TDD and TDMA.

3.8 Antennas

The choice of antennas has a great impact on the capacity and coverage of fixed wireless systems. The choice is based on the antenna's efficient frequency of operation, bandwidth, and directivity characteristics. (Anderson 2003, p. 232)

3.8.1 *Antenna characteristics and parameters*

For a system designer, the most significant characteristics of antennas are the radiation pattern, directivity, and gain. Furthermore, the bandwidth and polarization of the antennas have to be taken into account when designing a system.

The *directivity* of an antenna is used to determine the ability of the antenna to focus energy in a particular direction when transmitting, and to reject undesired energy

coming from other directions when receiving. It is defined as the ratio of the radiation power density in the direction (θ, ϕ) to the average radiation power density.

The *gain* of an antenna is the most commonly used characteristic of an antenna, giving the amount of power radiated in a certain direction using only the power at the input terminals of the antenna. Usually, only the maximum gain of the antenna is presented, and expressed in dBi, i.e. decibels relative to an isotropic radiator.

The *beamwidth* of an antenna is the angle between which the intensity of radiated power has dropped to half the maximum value. The *bandwidth*, on the other hand, is the frequency difference for which the radiated power in a given direction is within 3 dB of the radiation at the nominal center frequency of the antenna.

The orientation of the electric field defines the *polarization* of the electromagnetic wave. The waves can have linear (horizontal or vertical), circular, or elliptical polarizations, each having different kind of reflection characteristics. For fixed line-of-sight systems, polarization discrimination allows the doubling of the system capacity without the need for more bandwidth or more efficient modulation.

(Anderson 2003, p. 190-202, Ibe 2002, p. 32-35)

3.8.2 Base station sector antennas

A point-to-multipoint FWA network consists of a number of sectorized base stations, each sector connecting to multiple CPEs. In the base station one directional sector antenna is required for each sector.

The sector antennas are directional antennas with beamwidths varying from 15 degrees up to 360 degrees. The beamwidth of the antennas depends both on the service area and the capacity requirements of the system. A base station with one sector using an omnidirectional antenna has a quarter of the capacity of a four-sector system with 90-degree sector antennas.

The antenna types used in sector antennas depend on the frequency band in use. At the frequencies below 10 GHz, the sector antennas are usually arrays of dipoles or slots, either in a linear or planar configuration. The antenna arrays are panel-shaped, and generically described as panel antennas. Sector antennas have to be capable of handling

sufficient power levels and bandwidths, which might exclude some antenna types such as microstrip antennas. (Anderson 2003, p. 209)

3.8.3 *CPE antennas*

The CPE antenna type depends on the non-line-of-sight capabilities of the system. In a line-of-sight FWA network, the CPE antennas are highly directional and installed outdoors by a professional technician. In non-line-of-sight systems, the beamwidth of the CPE antenna is typically larger, and in the case of user-installable CPEs the antenna should be omni-directional.

3.8.4 *Advanced antenna systems*

The performance and capacity of wireless communication systems are limited by three major impairments: fading, delay spread, and interference. Advanced antenna systems, including diversity systems, adaptive antenna systems, and MIMO antenna systems, can be used in FWA networks to mitigate these impairments.

Antenna diversity systems are used to reduce signal amplitude fading caused by multipath propagation. The systems use multiple antennas in the receiver/transmitter for space diversity. The idea is that signals received from multiple antennas will have independent, preferably uncorrelated fading. The signals from different antennas can then be constructively combined, using one of three basic processing techniques: switched, equal gain, or maximal ratio combining. (Murch & Letaief 2002)

Adaptive antenna systems, or smart antennas, are used to cope with co-channel interference. These systems use adaptive array processing to shape the antenna radiation pattern, enhancing the desired signals and nulling the interfering signals. The processing is generally known as optimum combining, and requires a known training sequence to be transmitted along with the actual data. The received training sequence is compared to the original one, and the antenna array is adjusted to minimize the difference between the two. This aims to optimal reception of the data and minimal co-channel interference. (Murch & Letaief 2002)

MIMO antenna systems use multiple antennas at both the transmitter and the receiver. The idea is that the channel responses between the various channels between the different antennas are sufficiently uncorrelated, and signal processing can be used to

distinct multiple, non-interfering channels between the transmitter and the receiver. Thus, multiple data streams can be transmitted simultaneously, increasing the capacity of the system without a need for extra bandwidth. (Anderson 2003, p. 223-224)

The IEEE 802.16 standards support systems using certain kinds of advanced antenna systems. Some FWA manufacturers have also announced products utilizing MIMO antennas. In the thesis, however, the focus is on systems using traditional antenna types.

3.9 Commercially available FWA systems

In the previous sections, a number of technical features and alternatives for FWA networks were introduced. Technical standards for FWA networks were also discussed. To get an overview of the technology used in actual products found in the market, Table 3.4 presents the technical features of some FWA systems, based on the information found on equipment manufacturers' web pages.

Table 3.4: Technical features of some commercial 3.5 GHz FWA systems

Manufacturer	Alvarion	Cambridge Broadband	Navini	Redline Communications	Wi-LAN
System	BreezeAccess OFDM	VectaStar 3500	Ripwave	AN-100	Libra 3000
Duplexing	FDD	FDD	TDD	TDD / H-FDD	FDD
Multiple access	CSMA/CA	TDMA	Multi-carrier CDMA	TDMA	TDMA
Modulation	OFDM, 64 FFT points, BPSK, QPSK, 16QAM, 64QAM	Single carrier, QPSK, 16QAM, 64QAM	Adaptive, Downlink: 16-QAM, 8-BPSK, QPSK Uplink: QPSK	OFDM, adaptive, BPSK, QPSK, 16-QAM, 64-QAM	OFDM, BPSK, QPSK, 16-QAM
Channel bandwidth	2 x 1.75 MHz, 2 x 3.5 MHz	1.75 MHz, 3.5 MHz, 7 MHz, 14 MHz	3 MHz, 5 MHz	3.5 MHz, 7 MHz, 14 MHz	3.5 MHz, 7 MHz
Max. net throughput (Channel / modulation)	12 Mbps (3.5 MHz, 64QAM)	48 Mbps (14 MHz, 64QAM)	4.2 Mbps downlink, 2.2 Mbps uplink (5 MHz, 16QAM / QPSK)	35 Mbps (14 MHz, 64-QAM)	12 Mbps (7 MHz, 16-QAM)
BS transmit power		25 dBm, 29 dBm, 33.5 dBm	27 – 47 dBm EIRP per antenna element	23 dBm	22 / 32 dBm (average / peak)
BS sector antenna	16.5 dBi, 60°	13.5 dBi, 90°	360° or 120°	17 dBi, 60° 14 dBi, 90°	17dBi, 60° 14dBi, 90° 13dBi, 120° 13dBi, 180° 11dBi, Omni
CPE transmit power		25 dBm, 29 dBm, 33.5 dBm	31 dBm EIRP	15 dBm	17 / 27 dBm (average / peak)
CPE antenna	18 dBi, 20°	16.5 dBi, 23°	User installable, 2 dBi, 360° 6 dBi, 120°	18 dBi 15° 24 dBi 8°	18 dBi 20° 21 dBi 12° 23 dBi 9.6°
BS network interface	10/100 BaseT	STM-1	T1, ATM/IMA, 10/100 BaseT	T1/E1, 10/100 BaseT	10/100 BaseT
CPE network interface	10/100 BaseT	10/100 BaseT, G.703 E1, V.35, STM-1	USB, 10-BaseT	T1/E1, 10/100 BaseT	10/100 BaseT

As discussed, the IEEE 802.16 standards are likely to have an impact on the FWA market in the next few years. A number of vendors have already announced their plans to produce equipment complying with the 802.16a standard, aiming for interoperability and WiMAX certification. Although certified products are not yet available at the market, some manufacturers are already shipping products promised to be interoperable with the future WiMAX-certified products.

3.10 Chapter summary

All the FWA systems currently available in the market are based on proprietary technologies and not interoperable with each other. FWA standards from IEEE and ETSI are expected to have a considerable impact on the industry, by allowing interoperability and lower prices for the equipment.

The IEEE Std 802.16a-2003 and ETSI HIPERMAN standards have been designed for non-line-of-sight operation. This improves the coverage of the FWA base stations and sectors and makes the provisioning of the subscriptions easier. In non-line-of-sight networks the subscribers can often install the CPEs by themselves, whereas in line-of-sight networks professional technicians are required. This reduces the provisioning costs significantly. Also, the marketing of the service becomes easier if the connections can be “guaranteed” to work in every location inside the service area.

The focus of the thesis is on systems conforming to the IEEE 802.16 standards and especially the OFDM PHY layer specification of the 802.16a. Although certified products are not yet available at the market, several manufacturers have announced to support the standard in their product lines. Some manufacturers are already shipping products promised to be interoperable with the future WiMAX-certified products, allowing operators to start building the networks right away.

4 FWA network dimensioning and planning

Chapter 3 introduced the key technologies and standards of FWA networks, together with some products found in the market. In order to proceed to the actual techno-economic analyses of the networks, the general principles of network dimensioning and planning have to be understood. Estimation of the required number of FWA base stations and sectors for a certain area is essential in order to achieve reliable results from the techno-economic analyses.

This chapter introduces the main concepts and general principles of FWA network dimensioning and planning. First, the selection of frequency band and FWA system to be used is made. Channel models used to predict the base station range and coverage of the selected system are then introduced. Capacity and coverage planning methods for FWA networks are also discussed. The chapter ends with a brief discussion on frequency planning and radio channel assignment related matters.

4.1 Frequency band and system selection

4.1.1 Frequency band selection

When planning a FWA network, the operator has to make a choice between the available frequency bands. A number of things have to be considered before making the selection, including the following:

- availability of spectrum licenses,
- aggregate capacity demand in the service area,
- subscriber density in the service area,
- geography of the service area, e.g. building heights, differences in altitude,
- interference levels in the unlicensed bands, and
- cost of radio equipment.

The selection of the frequency band to be used has a major effect on the dimensioning and planning of the FWA network. In the lower frequency bands, the signal propagation characteristics are better, but less bandwidth is available. An important thing to consider is whether the number of customers connecting to a single FWA base station is limited by the capacity or by the coverage of the base station. In rural and sparsely populated areas, the number of customers that can be connected is likely to depend on the

coverage of the base station. In densely populated areas, however, the number of customer in the coverage area of one base station is likely to be so high that additional base stations have to be built in order to be able to serve all the customers.

The choice between licensed and unlicensed bands may also prove to be difficult. The licensed nature of the 3.5 GHz, 10.5 GHz, and 26 GHz bands protects the FWA systems from inter-system interference, and limits the number of operators in a certain geographical area. In the unlicensed bands, the interference levels cannot be easily predicted, and might become a problem at certain areas. The coverage of the base stations is very limited due to the strict radiation power limits. The most important thing leading operators to use the 2.4 GHz ISM band are the low prices of the WLAN equipment used to provide FWA services. Also the lack of spectrum licenses might drive the operators to use unlicensed spectrum.

Table 4.1 shows the possible frequency bands and their characteristics.

Table 4.1: Typical characteristics of FWA systems in different frequency bands

	2.4 GHz ISM	3.5 GHz FWA	26 GHz FWA
Operating frequency	2.4 GHz	3.5 GHz	26 GHz
Frequency allocation	83.5 MHz unlicensed	2 x 28 MHz	2 x 112 MHz
Channel bandwidth	22 MHz	7 MHz	28 MHz
Channels available	4	8	8
Maximum transmit power	20 dBm (100 mW)	35 dBm (~3.2 W)	27 dBm (~500 mW)

For the purposes of this thesis, the 3.5 GHz FWA band was chosen as the most interesting one and the one to be analyzed. The decision was based on the following facts:

- The band is licensed
 - Interference is in control
 - Higher transmission powers are allowed
- The frequencies of the band are sufficiently low
 - Range and coverage are better than in 10.5 GHz and 26 GHz bands
 - Operation in non-line-of-sight conditions is possible
- Sufficiently high data rates of about 15 Mbps per sector are possible.

The 3.5 GHz FWA band is also the one that has gained the most interest among Finnish operators. In many of the largest cities of Finland, the licenses for the band are no longer available (Ficora 2003).

4.1.2 System characteristics

IEEE Std 802.16a-2003 is used as a base when selecting the system for the 3.5 GHz band. Certified interoperability is seen as a must, which leads to the use of a system based on the OFDM PHY layer specification of the standard. The main characteristics of the selected system are listed in Table 4.2.

Table 4.2: Characteristics of the selected 802.16 WirelessMAN™-OFDM based system

PHY layer specification	WirelessMAN™-OFDM (IEEE Std 802.16a-2003)
Duplexing	TDD
Multiple access	TDM / TDMA
Modulation	Adaptive QPSK / 16-QAM / 64-QAM
Channel bandwidth	7 MHz
BS Tx power (average/peak)	25 dBm / 35 dBm
BS antenna beamwidth and gain	120°, 14 dBi 60°, 17 dBi
CPE Tx power	23 dBm
CPE antenna beamwidth and gain	User-installable indoor antenna: 360°, 6 dBi Directional outdoor antenna: 20°, 18 dBi
CPE antenna diversity	Yes

In the following sections, network planning methods suitable for the selected frequency band and system are introduced.

4.2 Channel models for FWA networks

Channel models are fundamental tools when designing any wireless network. Basically, the models predict how the radio signal is weakened and distorted between a transmitter and a receiver. Channel models can be divided into three basic groups: theoretical, physical, and empirical models.

Theoretical channel models are based on some theoretical assumptions about the propagation environment. They are useful for analytical studies of the behavior of communication systems, but not suitable for planning communication systems to serve a particular area. These models will not be treated further in this thesis.

Physical channel models predict signal attenuation and channel response by making use of the physical mechanisms of electromagnetic wave propagation. These models are the most widely used when planning FWA networks for specific and known areas. They make use of site-specific data on e.g. terrain elevation, heights of buildings and trees,

rain intensity rates etc. In this thesis the network planning is made for non-specific, hypothetical areas, where physical channel models are not very practical.

Empirical channel models are based on measurements and observations in real propagation environments. These models offer simple predictions for different environments without the need for detailed propagation environment databases. The simplicity of the models limits their use to *system dimensioning*, i.e. approximate counting of base station sites needed to serve an area.

(Anderson 2003, p. 71-97)

Empirical models are the ones most useful for the purposes of this thesis. An example of these are the Stanford University Interim (SUI) channel models included in the IEEE Std 802.16a-2003™, introduced in Section 4.3.

4.2.1 Path loss models

The basic formula for free space path loss is as follows:

$$L_f = 20 \cdot \log_{10} \left(\frac{\lambda}{4\pi d} \right) = 32.44 + 20 \log f + 20 \log d \quad \text{dB}, \quad (4.1)$$

where λ is the wavelength, f is the frequency in MHz, and d is the distance in km. This is a common starting point to designing wireless systems. (Anderson 2003, p. 32)

More generally, the mean value of path loss can be modeled using a log-distance path loss model:

$$L = L_{d_0} + 10n \log_{10} \left(\frac{d}{d_0} \right) = 20 \cdot \log_{10} \left(\frac{\lambda}{4\pi d_0} \right) + 10n \log_{10} \left(\frac{d}{d_0} \right) \quad \text{dB}, \quad (4.2)$$

where d_0 is a reference path loss, L_{d_0} is the path loss at $d = d_0$, and n is the path loss exponent.

The reference path loss can be based e.g. on field measurements, or free space path loss as in Eq. 4.2. The path loss exponent is found by field measurements, and it usually varies between 2 and 5 (Rappaport 2002).

The log-distance path loss models are often extended with additional correction factors, making the models applicable to e.g. different operating frequencies and antenna heights.

(Kelly & Sarajedini 2002)

4.2.2 *Fading models*

The path loss models introduced above give one path loss value for all links of certain length. In reality, however, the link condition between a base station and CPEs vary as a function of time, causing the path loss to deviate around some mean value. The mean path loss values also vary between different links of same length. When designing and planning a network, this signal level uncertainty is taken into account by using fading models.

In non-line-of sight FWA links, signal level uncertainty comes from two main sources. Firstly, the locations of the CPEs are different. Some CPEs are located behind tall buildings or dense vegetation, while some have more clear view to a base station. This kind of location variability and uncertainty is modeled with shadow fading models. Secondly, the signal conditions between a base station and a certain CPE vary also as a function of time, as people and cars pass by and trees and leaves are moving in the wind. This time variability is modeled with multipath fading models. (Anderson 2003, p.153)

Shadow fading describes the variation in the mean value of the multipath fading distribution. Shadow fading distribution is usually modeled as a lognormal distribution that describes the variation of the decibel value of the mean signal as a normal or Gaussian distribution. (Anderson 2003, p. 160)

Multipath fading is usually modeled using Ricean or Rayleigh distributions. The models assume that the signal is sufficiently narrowband so that the fading is flat, i.e. not frequency-selective. In OFDM systems, a wide frequency band is divided into multiple subcarriers, each of which is assumed to experience flat fading. (Anderson 2003, p. 154)

4.3 Path loss models for the thesis

Suitable path loss models are required in order to determine the coverage areas of FWA cells as accurately as possible. Unfortunately, empirical models for non-line-of-sight systems operating at the 3.5 GHz frequency bands have apparently not been published.

Path loss model primarily designed for other frequency bands were have to be used in the thesis.

For the thesis, two different channel models were chosen to approximate the range and coverage of FWA cells. For urban and suburban areas the path loss models included in the IEEE Std 802.16a-2003™ were chosen. For rural areas, line-of-sight channel obstructed and attenuated by vegetation was assumed to be suitable.

4.3.1 IEEE 802.16 path loss model

IEEE Std 802.16a-2003™ includes a path loss model originally proposed by Erceg et al. (1999). The path loss model was created based on empirical studies of radio systems in the suburban areas of United States. As such, the model is considered to be suitable for both the urban and suburban areas of Finland.

The path loss model is derived from experimental data collected by AT&T Wireless Services across the United States in 95 existing macrocells at 1.9 GHz. The model is for suburban areas, and it distinguishes between three different terrain categories. The model applies to base station antenna heights from 10 to 80 m, and distances from 0.1 to 8 km. (Erceg et al. 1999)

According to the model, path loss of a link is calculated as follows:

$$L = L_{d_0} + 10n \log_{10} \left(\frac{d}{d_0} \right) + \Delta L_f + \Delta L_h + s \text{ dB}, \quad (4.3)$$

where

- L_{d_0} is the free space path loss at d_0 ,
- $d_0 = 100$ meters,
- n is the path loss exponent,
- d is the distance in meters,
- ΔL_f is the frequency correction term,
- ΔL_h is the receive antenna height correction term, and
- s is the shadow fading component.

The path loss exponent n is calculated as follows:

$$n = a - b \cdot h_b + \frac{c}{h_b}, \quad (4.4)$$

where h_b is the height of the base station and a , b , and c are constants representing a certain terrain category. The terrain categories and the respective constants are shown in Table 4.3, together with examples of path loss exponents calculated at base station heights 30m and 50m.

Table 4.3: Model parameters for IEEE 802.16 channel models (Erceg et al. 1999)

Model parameter	Terrain Type A (Hilly, heavy trees)	Terrain Type B (Intermediate)	Terrain Type C (Flat, few trees)
A	4.6	4	3.6
B	0.0075	0.0065	0.005
C	12.6	17.1	20
n ($h_b=30$ m)	4.795	4.375	4.117
n ($h_b=50$ m)	4.477	4.017	3.750

Exemplary path loss curves for the different terrain categories are shown in Figure 4.1. These were calculated using the path loss model with channel frequency 3500 MHz, BS antenna height 30m, and Rx antenna height 6m. The free space path loss according to the Friis' model (Eq. 4.1) is also shown.

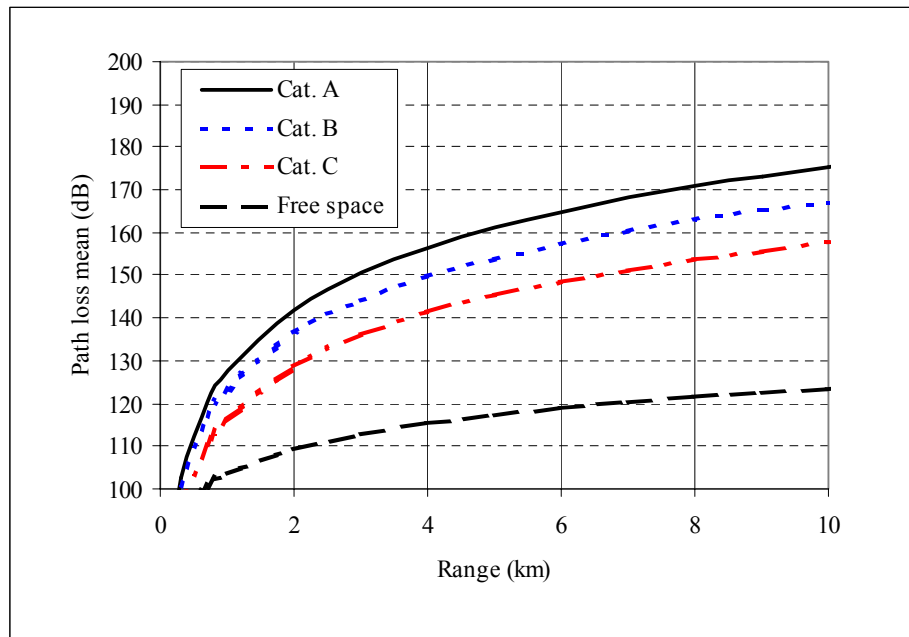

Figure 4.1: Exemplary path loss curves calculated using the 802.16 channel models and the Friis' free space path loss model

The shadowing fading component s in the path loss formula represents location variability, i.e. variation of the path loss value around its mean in different CPE locations within a macrocell. It is a zero-mean variable that follows lognormal distribution. The standard deviation of s varies between 8.2 and 10.6 dB, depending on the terrain type.

(Erceg et al. 1999)

4.3.2 Path loss model for rural areas

For rural areas, the free space path loss model of Eq. 4.1 can be used, extended with a term representing excess attenuation in vegetation.

Radio signal attenuation in vegetation is treated in ITU-R Recommendation P.833. According to the recommendation, the excess attenuation A_{ev} due to the presence of vegetation is given by:

$$A_{ev} = A_m \left[1 - \exp\left(\frac{-d \cdot \gamma}{A_m}\right) \right], \quad (4.5)$$

where

- d is the length of path within woodland (m),
- γ is the specific attenuation for very short vegetative paths (dB/m), and
- A_m is the maximum attenuation for one terminal within a specific type and depth of vegetation (dB).

Figure 4.2 illustrates the situation.

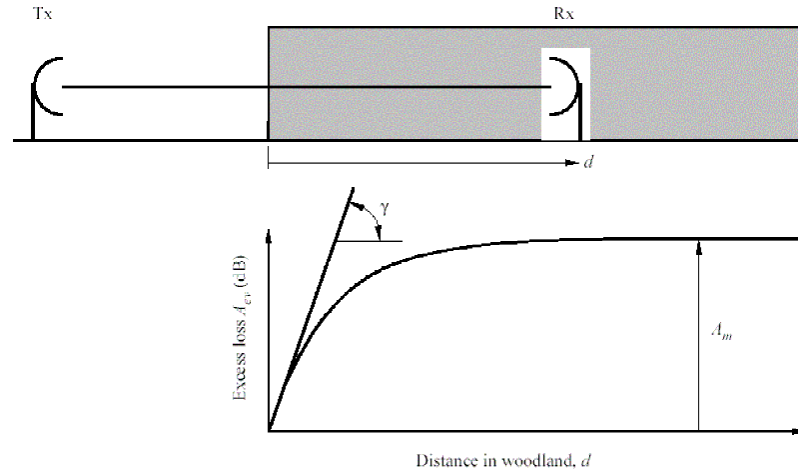

Figure 4.2: Representative radio path in woodland (ITU-R Rec. P.833)

The value of γ depends on the species and density of the vegetation, and the frequency band of operation. Based on measurements, an approximate value 0.7 dB/m is given in the recommendation for systems operating at 3.5 GHz bands.

The maximum attenuation A_m depends on the species and density of the vegetation, the antenna pattern of the terminal within the vegetation, and the vertical distance between the antenna and the top of the vegetation. The frequency dependency of A_m is of the following form:

$$A_m = A_1 \cdot f^\alpha \quad (4.6)$$

where A_1 and α are coefficients derived from various experiments, and f is the operating frequency (MHz).

According to the recommendation, measurements in the frequency range 900-2200 MHz carried out in a French forest on paths varying in length from a few hundred meters to 6 km with various species of trees of mean height 15 m have yielded $A_1 = 1.15$ dB and $\alpha = 0.43$. In the measurements, receiving antenna height of 1.6 m and transmitting antenna height of 25 m were used. The standard deviation of the measurements was 8.7 dB, and seasonal variation of 2 dB at 900 MHz and 8.5 dB at 2200 MHz were observed.

(ITU-R Recommendation P.833)

Using these values, A_m for the 3.5 GHz frequency band can be calculated as follows:

$$A_m = A_1 \cdot f^\alpha = 1.15 \times 3500^{0.43} \approx 38.43 \text{ (dB)}.$$

Based on this, the excess attenuation A_{ev} as a function of distance can be calculated and plotted as in Figure 4.3.

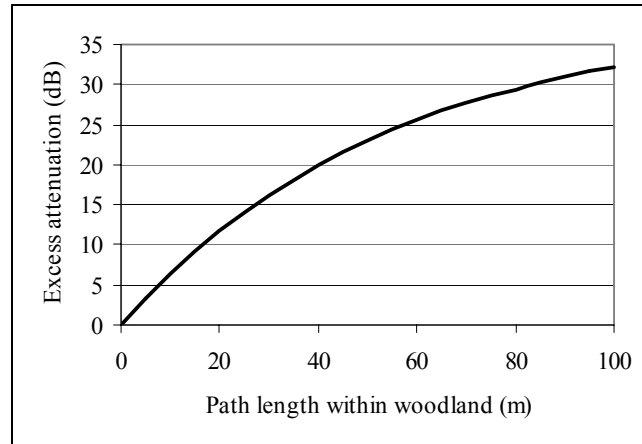

Figure 4.3: Attenuation in vegetation as a function of distance for a 3.5 GHz signal

The reliability of these figures can be questioned, as measurement results have not been published for the 3.5 GHz band. Also, the situation in Finland is likely to be more severe because of heavy load of snow on the forests and trees in winter. More reliable figures would require actual field measurements, not in the scope of the thesis.

4.4 Capacity planning

The objective of capacity planning is to calculate the required number of FWA base stations and sectors to fulfill the traffic capacity demands of all the subscribers in a given service area.

4.4.1 Aggregate traffic and concentration

The first step in capacity planning is prediction of aggregate subscriber traffic in the service area. It depends on the number of potential customers (i.e. households) in the area, expected penetration of broadband services, expected market share, and expected traffic demands of the subscribers.

Also, an important decision has to be made on traffic concentration. Internet traffic is bursty, and subscribers are not likely to transmit at full throughput speeds all at the same time. Therefore, statistical multiplexing can be utilized to save resources. For

example, with a traffic concentration factor of 10, a FWA sector with maximum net throughput of 15 Mbps could be used to serve 150 subscribers subscribing to a 512/512 kbps service.

The concentration factor should be high to minimize the number of base station sectors and low enough to keep the customers satisfied with the service. The choice of a suitable concentration factor depends on the applications the subscribers are using. If the subscribers were only using the broadband connection to read their e-mails and browse the web, a high concentration factor could be used. New broadband services, such as video and music streaming have higher capacity demands and require constant throughput from the network. Some applications, such as peer-to-peer file sharing are even more problematic from the traffic concentration point of view. A subscriber sharing and downloading video files may be transmitting and receiving at maximum speed for many hours or even all the time. Countermeasures against these problems are discussed e.g. in Anttila (2003).

4.4.2 Adaptive modulation and average sector capacity

As discussed in Chapter 3, each FWA base station consists of a number of sectors. The traffic capacities of these sectors depend most importantly on the modulation and coding methods and the bandwidth of the radio channel in use. The sector capacity is divided between all the subscribers in the sector's coverage area. In a TDD system the same frequency channel is used for both upstream and downstream transmissions.

Because of the adaptive modulation mechanisms used in modern FWA networks, the capacity of a single base station sector depends on the distance and link conditions between the base station and the CPEs. Connections to CPEs located near the base station can be provided using more efficient modulation schemes (i.e. using a larger number of levels) than with CPEs that are far away from the base station.

For network dimensioning purposes, the average capacity of an FWA sector can be calculated, as follows.

Table 4.4 shows raw bitrates and receiver sensitivity requirements for a 802.16a OFDM-based system (IEEE Std 802.16a-2003™). The receiver sensitivity is the minimum signal level that must be received in order to decode the data stream with a certain acceptable bit error rate. The data rates are calculated assuming a channel

bandwidth of 7 MHz. The ratio between cyclic prefix time and useful time in an OFDM symbol (T_g/T_b) is assumed to be 1/16.

Table 4.4: Normalized ranges and coverage areas of different modulations

Modulation	Code Rate	Raw bitrate (Mbps)	Receiver sensitivity (dBm)	Normalized range	Normalized area
QPSK	1/2	5.76	-84	2.37	5.62
QPSK	3/4	8.65	-82	2.11	4.47
16-QAM	1/2	11.53	-77	1.58	2.51
16-QAM	3/4	17.29	-75	1.41	2.00
64-QAM	2/3	23.06	-71	1.12	1.26
64-QAM	3/4	25.94	-69	1	1

Table 4.4 shows also the normalized ranges and coverage areas of the different modulations. These are calculated assuming a log-distance path loss model with a path loss exponent of 4. When the normalized range for the 64-QAM modulation with 3/4 code rate is set to be 1, the ranges of other modulations are dependent only on the differences in receiver sensitivities and on the path loss exponent. If the path loss exponent is decreased, the normalized range and area of more robust modulation methods increase.

Assuming that the subscribers within a FWA cell are distributed to the different modulation and coding classes in the same proportions as the normalized area figures show, the average raw bitrate in a sector can be calculated to be about 12 Mbps. If the cell is dimensioned so that 16-QAM modulation is available for all the subscribers, the average raw bitrate is about 20 Mbps.

According to Hoymann et al. (2003), the overall MAC overhead of HIPERMAN (i.e. 802.16a OFDM) systems is approximately 10%, meaning that about 90% of the raw bitrate is available to the upper layers. Therefore, the average throughput in one sector can be assumed to be 11-18 Mbps. For the purposes of the thesis, a sector capacity of 15 Mbps is assumed.

4.4.3 Number of sectors and base stations

The maximum number of subscribers to be connected to a single sector can be calculated as follows:

$$N_{subscribers} = \frac{T_{sector}}{(T_{D,ave} + T_{U,ave})} \times C, \quad (4.6)$$

where

- $N_{subscribers}$ is the maximum number of subscribers in one sector,
- T_{sector} is the traffic capacity (data rate) of one sector,
- $T_{D,ave}$ is the average downstream data rate of subscribers,
- $T_{U,ave}$ is the average upstream data rate of subscribers, and
- C is the concentration factor.

The capacity-based number of base station sectors is the ratio between the expected number of customers in a service area and the maximum number of subscribers in one sector. The number of base stations can then be calculated e.g. as 1/6 of sector amount.

4.5 Coverage planning

The objective of coverage planning is to ensure that the capacity-based amount of base stations is enough to reach the customers in a certain geographical area. The coverage planning is carried out with link budget calculations using suitable channel models and system parameters.

4.5.1 Link budgets

The link budget is a tabulation of all the gains and losses experienced by a radio signal between the transmitter and receiver. The link budget spreadsheet used in this thesis is shown in Table 4.5.

Table 4.5: Basic link budget

System element	Gain
Transmitter output power (dBm)	25,00
Transmitter transmission loss (dB)	-2,00
Transmitter antenna gain (dBi)	14,00
Effective radiated power (dBm)	37,00
Path length (km)	1,00
Path loss median	-120,00
Building / vegetation penetration loss (dB)	0,00
Total median path loss (dB)	-127,00
Receiver antenna gain (dBi)	18,00
Receiver transmission loss	-2,00
Median signal level at receiver input (dBm)	-74,00
Fade margin (dB)	10,00
Receiver sensitivity (QPSK 1/2)	-84,00
Margin (QPSK 1/2)	0,00

The maximum transmitter output power depends on regional regulations. In Europe, the maximum peak transmission power for TDMA equipment in the 3.5 GHz frequencies is 35 dBm (ETSI EN 301 021). The peak-to-average power ratio (PAPR) of OFDM modulation causes the average power to be lower. Here, a PAPR of 10 dBm is assumed.

The transmission losses in the transmitter and receiver include transmission line losses and other implementation losses between the radios and antennas.

The transmitter antenna gain depends mostly on the antenna beamwidth. In the thesis, base station sector antennas with beamwidths of 60° and 120° are considered, with gains of 17 dBi and 14 dBi, respectively. CPE antennas are either directional outdoor or omni-directional indoor antennas with gains of 18 dBi or 6 dBi.

The path loss between the transmitter and receiver antennas depends on the operating frequency, path length, and link conditions, e.g. terrain types, building types and densities, antenna heights etc. In the thesis, the median path loss is calculated using the channel models introduced in Section 4.3. A building penetration loss is added in case of indoor receiver antenna placements.

A fade margin has to be added to the median path loss to reach certain availability and reliability for the FWA links. The fade margin is calculated using the models introduced in Section 4.3.

The receiver sensitivity depends on the noise power level in the receiver and required SNR levels for different modulation and coding schemes. The IEEE Std 802.16a-2003 specifies the following levels for OFDM-based systems.

Table 4.6: Receiver minimum input level sensitivity (dBm) (IEEE Std 802.16a-2003)

Bandwidth (MHz)	QPSK		16-QAM		64-QAM	
	1/2	3/4	1/2	3/4	2/3	3/4
1.75	-90	-87	-83	-81	-77	-75
3.5	-87	-85	-80	-78	-74	-72
7	-84	-82	-77	-75	-71	-69
14	-81	-79	-74	-72	-68	-66

The final “margin” row in the link budget simply shows whether or not a link of certain lengths with certain system parameters is viable. When calculating the cell sizes, the range of a sector is given when the margin is zero.

4.5.2 Service availability vs. fade margins

The fade margin has a key role in the link budget. It depends on the coverage and reliability requirements of the operator for the system. For example, the requirement could be that the service has to be provided to 90% of all locations within a cell with 99.9% reliability, yielding some fade margin. If the coverage requirement is increased, the fade margin increases respectively, and the range of the base station cells becomes smaller.

4.5.3 Range of 3.5 GHz FWA base stations

Using the path loss models introduced in section 4.3, approximate ranges of 3.5 GHz FWA base stations can be calculated. The link budget calculations are shown in Appendix A.3. The results are gathered in Table 4.7.

Table 4.7: Coverage planning results: cell ranges in different environments

CPE antenna type	Outdoor (20°, 18 dBi)		Indoor (360°, 6 dBi)	
Coverage requirement	90%	99%	90%	99%
Urban / suburban environment:				
Category A (Hilly, heavy trees)	0.90	0.53	0.31	0.18
Category B (Intermediate)	1.19	0.70	0.37	0.22
Category C (Flat, few trees)	1.97	1.22	0.57	0.36
Rural environment:				
Line-of-sight	60.8 km	60.8 km	-	-
Line-of-sight with vegetation (15.7 dB excessive loss)	10 km	10 km	-	-

As Table 4.7 shows, the CPE antenna type has a great effect on the achievable cell range. In addition to 12 dBi lower antenna gain, a building penetration loss of about 10 dBi was assumed in the calculations, leading to considerable cell range reductions. In the case of indoor CPE antennas, the cell range is shown to be three to four times smaller than when using outdoor CPE antennas.

The effect of the coverage requirement is also visible in Table 4.7. By increasing the requirement from 90% to 99%, the cell range drops about 40 percent.

Based on the calculations, the following conclusions are made. In urban and suburban areas, the achievable range of FWA base station is assumed to be 0.5 / 1.5 km (indoor / outdoor CPE antennas). In rural areas, a range of 10 km is assumed to be possible using outdoor CPE antennas.

4.6 Frequency planning and channel assignments

The objective of the frequency planning is to assign a limited number of frequency channels to the base station sectors and to achieve minimal inter-cell interference. Because of the cellular structure of FWA networks, the frequency planning is performed very similarly to other cellular networks such as GSM.

A typical allocation from the 3.5 GHz frequency space is 2x21 MHz or 2x28 MHz. In the thesis, an allocation of 2x28 MHz is assumed, meaning that 8 channels with bandwidth of 7 MHz or 16 channels with bandwidth of 3.5 MHz are available for frequency planning.

4.6.1 Co-channel interference

In the thesis, it is assumed that 8 channels will be enough to deploy a system without losing any capacity due to co-channel interference between cells. Whether this would be the case in reality would require further study.

4.6.2 Channel assignments

When assigning frequencies to base station sectors two channels are used in each base station. In four-sector base stations this leads to frequency reuse of 2, and in six-sector base stations to frequency reuse of 3. Figure 4.4 shows possible frequency reuse patterns for base stations equipped with six and four sectors.

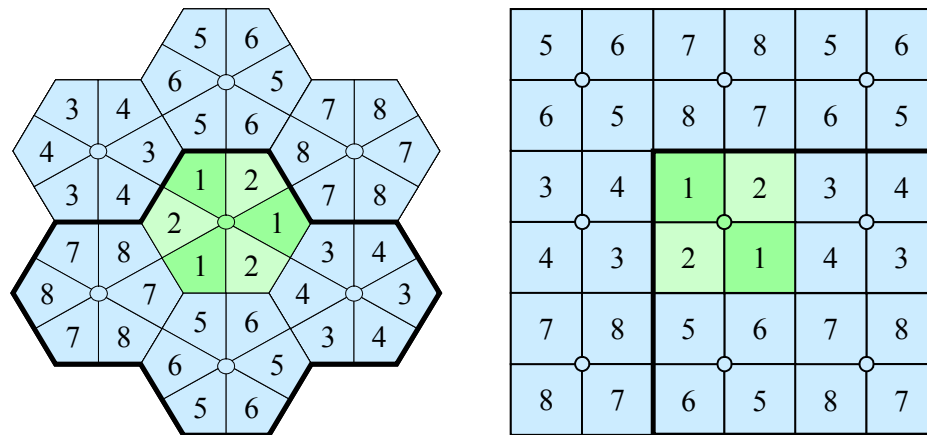

Figure 4.4: Possible frequency reuse patterns using 8 channels

4.7 Chapter summary

In the chapter, network dimensioning and planning methods for FWA were discussed. Systems operating at the 3.5 GHz frequency bands and conforming to the IEEE 802.16a standard and its OFDM physical layer specification were chosen to be used as the basis for the network dimensioning.

For the purposes of the thesis, path loss models based on empirical studies of similar systems are suitable. However, due to the lack of published material on non-line-of-sight channels in the 3.5 GHz bands, path loss models originally created for other frequency bands had to be extended and used.

Based on link budget calculations, the achievable ranges of FWA base stations were estimated to be as follows:

- 0.5 km for urban/suburban areas using indoor CPE antennas
- 1.5 km for urban/suburban areas using outdoor CPE antennas
- 10 km for rural areas using outdoor CPE antennas

The chapter gave only a brief overview to the FWA network dimensioning. In real service areas, more sophisticated planning methods would be required, utilizing e.g. digital maps with building locations and heights. The introduced methods are however sufficient for the theoretical service areas treated in the thesis.

5 Techno-economics of broadband access networks

Broadband services open up new revenue possibilities for operators. At the same time, the upgrading of access networks to support these services requires large investments, and many alternative technologies can be used. Techno-economic analyses are required to find out the optimal technologies and systems for different environments. In the thesis, these analyses are used to find out whether or not the FWA networks are really competitive against the other technologies.

For the purposes of this thesis, a "techno-economic analysis" is defined as an analysis seeking to determine the economic feasibility of a technology. Much of the terminology, methodology, and tools related to techno-economic analyses of broadband access networks have been developed in the various research projects funded by the European Union during the 1990's and the early 2000's. The research has been carried out under several Framework Programmes, in a number of projects listed in Table 5.1.

Table 5.1: Research related to techno-economics of broadband networks (CORDIS 2003)

Project name	Research Programme (Framework Programme)	Timeframe
TITAN (Tool for Introduction scenario and Techno-economic evaluation of Access Network)	RACE II (FP3)	1990-1994
OPTIMUM (OPTImised architectures for MULTiMedia networks and services)	ACTS (FP4)	1994-1998
TERA (Techno-Economic Results from ACTS)	ACTS (FP4)	1994-1998
TONIC (TechnO-EcoNomICs of IP optimised networks and services)	IST (FP5)	1998-2002

In this thesis, the analyses are carried out using the methods and tools developed in the above-mentioned research projects. The development of the methodologies and tools is set to continue in 2004 in the ECOSYS (techno-ECONomics of integrated communication SYStems and services) project of the European R&D programme CELTIC (CELTIC, 2004).

In the following sections, the most important aspects of the techno-economic analyses are introduced. The required inputs to and outputs from the analyses are discussed, as well as the assessment of the reliability of the results by the means of risk and

sensitivity analyses. Furthermore, a software tool used to perform the actual calculations is introduced.

5.1 Inputs to the techno-economic analyses

A number of choices, assumptions, and predictions have to be made before proceeding to the techno-economic analysis of a broadband access network. These include the selection of the geographical areas and customer segments to be served, the services to be provided, and the technology to be used to provide the services. Assumptions and predictions are needed e.g. on the level of competition in the market, the penetration rates of different throughput classes, and the price evolution of service tariffs and network components.

5.1.1 Scenarios as inputs

Ravera et al. (1998) propose a framework for the description of access network evolutionary paths. The framework provides a guideline for quantitative analyses of access network upgrades, taking into account the technical aspects of the networks, the environmental and market characteristics, and the services to be offered. As such, the framework is very suitable for the purposes of this thesis.

In the framework, *scenarios* are used to depict the access network evolution from the existing situation to the long term company target. A scenario is defined as a description of a network environment, including one or several operators providing a set of services to a number of users within a certain area and timeframe. A complete scenario is composed of the regulatory, environmental, service, and technology scenarios, each characterized by a number of scenario attributes.

The *regulatory scenario* describes the tariff structures and the revenues of the operators, as well as the sharing of the potential market between the operators. The attributes to be defined include the number of competitors both in the service market and access network provisioning, and the percentage shares of the competitors in these markets.

The *environmental scenario* describes the geographic and demographic characteristics of the area that is to be provided with a new network or a network upgrade. In addition, the existing network infrastructure is described.

The *service scenario* describes the services provided to the end-users by the service operators. The time evolution of the penetrations and the tariffs of these services are also defined.

The *technology scenario* describes the technologies, systems, and architectures that are used to provide the selected services to the end-users. The evolutionary steps between the existing network and the final network architecture are defined. Also, the cost of network equipment and installation, together with the cost of operations, administration, and maintenance (OA&M) procedures are defined.

(Ravera et al. 1998)

Table 5.2: Scenarios and scenario attributes (Ravera et al. 1998)

Scenario	Scenario attributes
Regulatory scenario	Number of competitors in the service operator market Number of competitors in the network operator market Market shares of the competitors
Environmental scenario	Type of area: - customer density - type of living units - customer expenditures on telecommunications services - cost of civil works - mean loop length Existing network infrastructure: - initial duct availability - percentage of network infrastructure which need substitution - initial network occupancy
Service scenario	Service types Penetration of services Subscription tariffs
Technology scenario	Network architecture and technologies Cost of network equipment and installation Cost of operation, administration, and maintenance procedures

The scenario attributes are not fixed figures, but change over time to a certain direction. Accordingly, the attributes have to be defined as time series for the whole study period.

5.1.2 Capital and operational expenditures

The costs of building and operating a broadband network can be divided into capital expenditures (CAPEX) and operational expenditures (OPEX). CAPEX includes the investments to the network infrastructure and devices, as well as the hardware required for the OAM&P functions, such as network management systems and billing and charging systems. OPEX includes the labor costs and expenses originating from

operating and managing the networks, as well as costs related to e.g. marketing, sales, and customer care.

The operational expenditures of network operators are often referred to as OA&M or OAM&P costs, the letters representing operations, administration, maintenance, and provisioning. According to the ITU Recommendation M.60,

***operations** include the operation of support centers/systems as well as personnel and training required to install and maintain the network elements;*

***administration** ensures the service level once the network elements have established the service;*

***maintenance** includes carrying out the preventive measurements and locating and clearing faults; and*

***provisioning** makes available the service by installing and setting-up the network elements.*

The operational expenditures related to a certain project are often more difficult to predict than the capital expenditures. This is especially true when new network technologies are considered, as previous experiences or data is not available. Often, the OAM&P costs are simply derived from the capital costs using a proper coefficient.

5.2 Outputs from the techno-economic analyses

5.2.1 Profitability

A prime answer from a techno-economic analysis is whether or not the investment project in question is profitable or not. Commonly used measures to determine the profitability of a project include the project's net present value, internal rate of return, and payback period.

The net present value (NPV) of an investment project is the most favorable measure of profitability, and leads to better investment decisions than the other criteria. The NPV of a project is calculated as the difference between the discounted value of the future incomes and the amount of the initial investment. The NPV rule states that a company

should invest in any project with a positive NPV. The discount rate, also known as the opportunity cost of capital, represents the expected return that is forgone by investing in the project rather than in comparable financial securities (Brealey & Myers 2000, p. 19-23)

The internal rate of return (IRR) of a project is closely related to the NPV. In fact, the discount rate that makes $NPV=0$ is also the IRR of a project. The IRR rule states that a company should accept investment opportunities offering IRR in excess of their opportunity cost of capital. Although commonly used in many companies, the IRR has some pitfalls and deficiencies compared to the NPV method. (Brealey & Myers 2000, p. 98-108)

The payback period of a project is the number of years it takes before the cumulative incomes equal the initial investments. When using the payback rule in investment decisions, all projects that pay themselves back before a defined cutoff date are considered profitable. The payback rule has some major deficiencies, including the fact that it ignores all cash flows after the cutoff date. Furthermore, it does not take the time value of money into account, but gives equal weight to all cash flows before the cutoff date. (Brealey & Myers 2000, p. 96-97)

5.2.2 Cash balance curve

Cash balance curve gives a simple and easily understandable overview of a project's profitability, and is a good tool to be used together with e.g. NPV. An example of a cash balance curve is given in Figure 5.1.

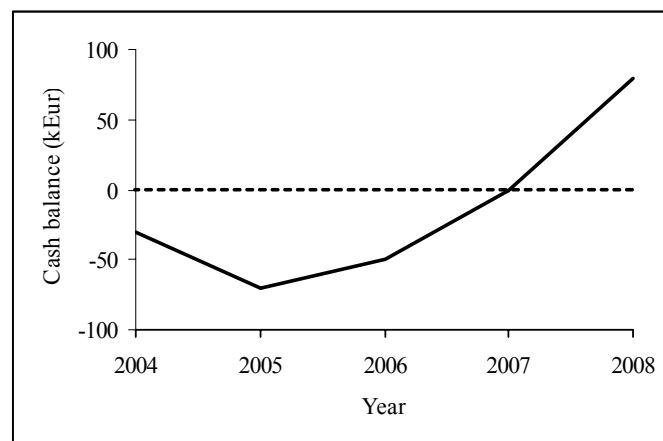

Figure 5.1: Example of a cash balance curve

The cash balance, or the cumulative cash flow time series, shows the impact of an investment project on the company's cash account. A typical cash balance curve for an access network project is first deeply negative because of the high initial investments. If the project turns out to be profitable, the cash flow turns positive fairly soon and the curve starts to rise. The lowest point in the curve gives the amount of funding required for the project. The point in time when the cash balance turns positive gives the payback period.

5.3 Risk and sensitivity analysis

As discussed earlier, the investment costs in access network upgrade projects are high. The lifetime of the investments is also expected to be many years, requiring the operators to make predictions for the distant future. These forecasts always hold a certain degree of uncertainty, the main sources of which, according to Olsen (1999), are the predicted service demands, the competition between operators, the costs of network components, and the costs of operating the new network architectures. These uncertainties and their effects on the viability of the investment projects are assessed by the means of risk and sensitivity analyses.

According to Pike & Neale (2003, p. 287), there are two broad approaches to handling risk in investment decision processes. In the first approach, the riskiness of a given project is *described* by using probability analyses or simpler methods such as sensitivity and scenario analyses. The second approach aims to *incorporate* the riskiness of a project directly within the NPV formula.

5.3.1 Sensitivity, scenario, and simulation analyses

Sensitivity analysis is a simple technique used to locate and assess the potential impact of risk on a project's value. The aim is to identify the impact of changes in key assumptions on the profitability (e.g. the NPV) of the project. The results of the sensitivity analysis can be plotted in a so-called sensitivity graph (Figure 5.2) that offers an illustrative view to the sensitivity of the variables. The sensitivity of each variable is reflected by the slope of the line – the steeper the line, the greater the impact of changes on the NPV.

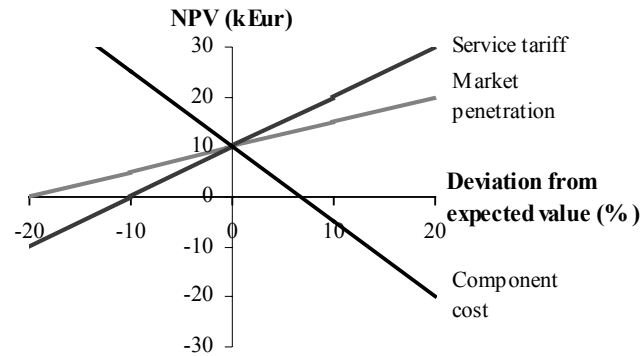

Figure 5.2: Example of a sensitivity graph (adapted from Pike & Neale 2003, p. 288)

Sensitivity analysis is a simple method and used widely in many companies. It can be used to identify the most critical factors of profitability. It cannot, however, be used to actually evaluate the risks related to these factors, as the probabilities of their deviations from the expected values are not assessed.

Sensitivity analysis considers the effects of changes in key assumptions only one at a time. In scenario analysis, many or all of the variables are changed simultaneously. This enables e.g. the worst and best case scenarios of a project to be analyzed.

Simulation analysis using e.g. Monte Carlo simulation is an extension to scenario analysis. In Monte Carlo simulation hundreds or thousands of possible scenarios, i.e. combinations of variables, are generated according to pre-defined probability distributions. Each scenario produces an NPV, and the NPVs of all scenarios together produce a probability distribution, which is the outcome of the simulation. In order to be useful, the Monte Carlo simulation requires probability distributions to be specified for all the variables, which is often very difficult.

(Pike & Neale 2003, p. 288-292)

5.3.2 Adjustments on the NPV formula

Besides describing the risks involved in a project, managers often want the risk to be incorporated also in the NPV formula. Two common methods exist for this purpose: the certainty equivalent method and the risk-adjusted discount rate method.

When using the certainty equivalent method, the NPV formula is adjusted by multiplying the expected annual cash flows, i.e. the numerator, by a certainty equivalent

coefficient. The coefficient reflects the management's risk attitude; the greater the aversion to risk, the nearer the coefficient is to zero, and the lower the NPV of a project becomes.

The risk-adjusted discount rate method adjusts the denominator of the NPV formula, by adding a risk premium to the risk-free discount rate. The higher the risk, the lower the net present value of a project becomes.

(Pike & Neale 2003, p. 292-294)

5.3.3 Risk and sensitivity analysis in the thesis

In the thesis, sensitivity analyses will be performed on the input parameters. Besides measuring riskiness, the sensitivity analyses are helpful in recognizing the parameters that have the strongest effect on the profitability of the FWA network deployments.

5.4 Techno-economic analyses using the TERA tool

The techno-economic analysis carried out in this thesis is done using a tool named TERA (Techno-Economic Results from ACTS). The TERA tool is a spreadsheet-based application for techno-economic assessment of communication networks and services. It was developed within the European Union ACTS (Advanced Communications Technologies and Services) Programme during the period of the Fourth Framework Programme of scientific research and development (1994-1998). (Bouillon et al. 2002)

TERA tool enables techno-economic evaluations and strategic analyses that combine high level parameters, such as density of subscribers and service penetration, with relevant low level parameters, such as costs of key network components (Lähteenoja et al. 1998).

As such, the TERA tool is very suitable for the purposes of this thesis. It is straightforward to use and adapts easily to the different scenarios constructed in the thesis. The outputs of the tool are easy to interpret and traceable to the inputs due to the visibility of the formulas in use. Another advantage is that the tool is freely available to the members of the TERA project, including Elisa Corporation.

5.4.1 TERA framework

The TERA framework for techno-economic evaluations is shown in Figure 5.3.

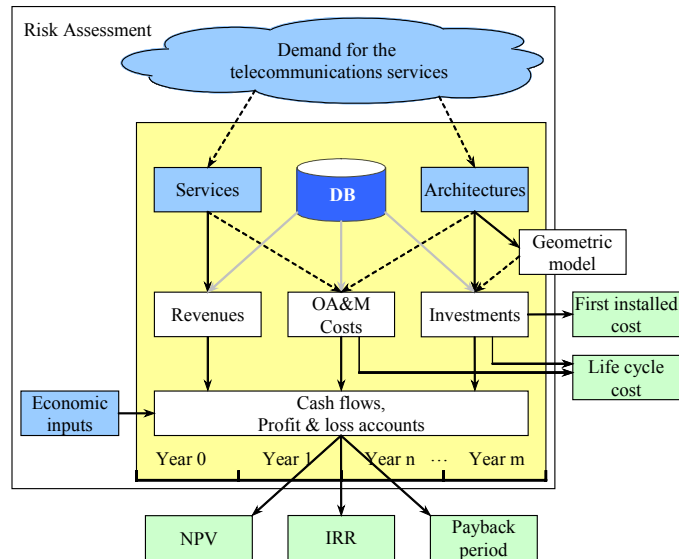

Figure 5.3: TERA framework for techno-economic evaluations (Olsen 1999)

As shown in the figure, the TERA tool requires certain market and technology related inputs, as well as general economic inputs in order to carry out the techno-economic analysis. Outputs from the analysis include revenues, costs, and investments, as well as profits, cash flows, and other economic key figures.

In the TERA framework, the analysis of an investment project is always performed for a certain user-defined *study period*. The *services* to be provided, and the market penetration of these services over the study period must be defined. For each service, a connection tariff and an annual tariff are defined as time series over the study period. The *revenues* for each year are calculated from the combination of yearly market penetration and tariff information.

The network *architectures* to provide the services must be defined, as well. This requires network planning expertise, and is done mostly outside the TERA framework. The result of the architecture definition is a shopping list that indicates the volumes of all network cost components for each year of the study period. A *geometric model* can be used to estimate the amount of cable, ducts, and civil works required in the access network.

The costs of the network components are calculated using a cost database integrated in the TERA tool. The network architecture and the shopping list together with the cost database give the *investments* for each year. The investments are usually spread over the

study period. The *first installed cost* is calculated by discounting all the investments to the start of the study period using the conventional discounting formula.

The *operation, administration, and maintenance costs* (OA&M) include the cost of repair parts, the cost of repair work, and the operation and administration costs. The first two of these are automatically calculated by the TERA tool with user-defined parameters, but the last one has to be included in the model manually. The investment costs together with the OA&M costs give the *life-cycle costs* of the project.

By combining the revenues, investments, OA&M costs, and general *economic inputs* such as discount rates and tax rates, the TERA tool calculates profits, cash flows, and standard economic indicators such as NPV, IRR, and payback period. The *profits* are calculated from the revenues, investments, depreciation, and taxes. The *retained cash flows* are calculated as the difference between the life-cycle costs and revenues minus taxes. The *cash balance* shows the cumulative cash flow for each year of the study period. The tool also calculates the *net present value* (NPV), the *internal rate of return* (IRR), and the *payback period* of the project.

(Olsen 1999)

5.4.2 Service definition

The services to be provided are entered into TERA as revenue components. The attributes of the revenue components are shown in Figure 5.4.

Attribute	Value
RevenueComponent	Revenue component example
Connection Fee	100
Annual Fee	600
Tariff Unit	Euro
Start Year	2003
K value for Connection fee	0.9
K value for Annual Fee	0.9
Start Penetration	10%
End Penetration	50%
Delay Time	5

Record: 1 of 1 (Filtered)

Figure 5.4: Attributes of revenue components in TERA

As shown, each revenue component has a name, a connection fee, and an annual fee. The expected tariff evolution is entered for both tariff components as a "K value", which is the factor by which the tariff is expected to increase or decrease annually. The expected evolution in service penetration is defined as an S-curve defined by three attributes: start penetration, end penetration, and the delay time between these.

5.4.3 Architecture definition

In the TERA tool, the network architecture is divided into a hierarchy of so-called network levels, which include flexibility points and link layers (Figure 5.5). This allows for the investments to be analyzed on the basis of their location in the network.

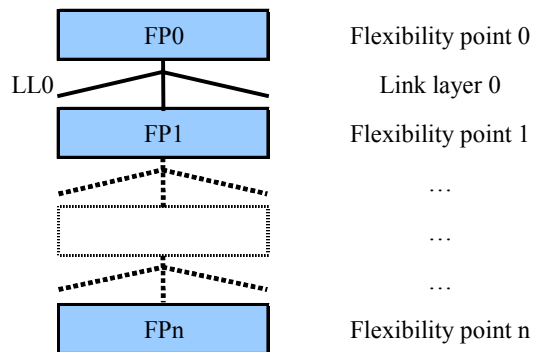

Figure 5.5: Architecture model of TERA tool

Each of the flexibility points and link layers holds a number of cost components. The total number of flexibility points and link layers is determined using proper network planning and dimensioning methods. Network planning and dimensioning must be done outside the TERA tool.

5.4.4 Network components

The network equipment and other infrastructure needed at each flexibility point and link level are entered into TERA as cost components. The attributes of the cost components are shown in Figure 5.6.

Attribute	Value
CostComponent	Cost component example
RefCostValue	1000
CostUnit	Euro
RefYear	2003
LearningCurveClassID	Electronics
VolumeClassID	New_Fast
MaintenanceMaterialClassID	2% class
MTBR_ClassID	10 years
MTTR_ClassID	8 hours
WrOffClassID	5 years
TypeID	Material/Electronics
ConfClassID	Conf_05
AddedBy	Tsm
YearOfEntry	11/26/03
Description	

Record: 1 of 1 (Filtered)

Figure 5.6: Attributes of cost components in TERA

As shown, each cost component has a name and a cost value for a certain reference year. In addition, each cost component is attached to a number of pre-defined classes.

The learning curve class and volume class define the component's cost evolution, discussed further in Chapter 5.4.5. The maintenance material, mean time between repair (MTBR), and mean time to repair (MTTR) classes define the amount of money that has to be spent on the maintenance of the component. The write-off class simply defines the write-off time of the component in the accounting. In addition, each component is attached to a certain type class and confidence class. The type class is used to find out the breakdown of total costs to e.g. electronics, cables, civil works etc. The confidence class is related to risk analyses done outside the tool, and not relevant for the purposes of the thesis.

5.4.5 Component cost evolution

Cost evolutions of the components are defined by attaching them to certain learning curve classes and volume classes.

A learning curve class gives the cost of the component as a function of produced volume with one parameter K , which is the factor by which the price is reduced when the production volume of the component is doubled. The K factor is a parameter

obtained from the production industry, and defined to be 0.8 for electronics in the TERA tool.

A volume class gives the manufactured volume as a function of time with two parameters Δt , and $n(0)$. These parameters define an S-shaped curve illustrated in Figure 5.7. (Olsen 1999)

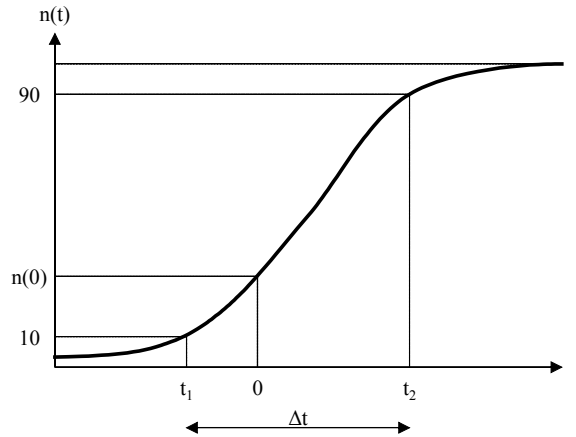

Figure 5.7: Forecast function for the evolution of manufacturing volume (Olsen 1999)

As shown in the figure, Δt is the time it takes for the production volume to increase from 10% to 90%, and $n(0)$ is the production volume at $t=0$.

The expression for the component cost evolution shown in the equation below. A complete derivation of the formula can be found in Olsen (1999).

$$P(t) = P(0) \cdot \left[n(0)^{-1} \cdot \left(1 + e^{\left\{ \ln[n(0)^{-1}-1] \cdot \left[\frac{2 \cdot \ln 9}{\Delta t} \right] \cdot t \right\}} \right)^{-1} \right]^{\log_2 K}$$

In TERA tool, a number of volume classes are pre-defined based on data from the industry, as shown in Table 5.3. The volume classes are always a combination of the two parameters, e.g. Emerging_Fast, New_Slow etc.

Table 5.3: Volume class parameters

Maturity level	N(0)	Growth speed	Δt
Emerging	0.001	Fast	5
New	0.01	Medium	10
Mature	0.1	Slow	20
Old	0.5	Very Slow	40

5.4.6 Operation, administration, and maintenance costs

In the TERA framework, OA&M costs are divided into three separate components, as shown in Figure 5.8.

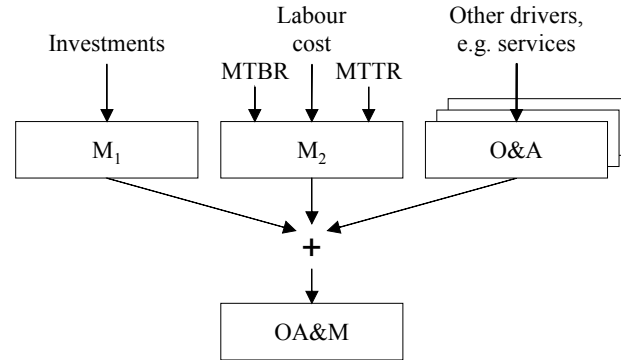

Figure 5.8: TERA OA&M methodology (Source: Olsen 1999)

M_1 represents the cost of repair parts. It is automatically calculated by the TERA tool, taking into account the cumulative investments on the network infrastructure and the maintenance cost percentages defined individually for each component in the network.

M_2 represents the cost of repair work, and is also automatically calculated by the TERA tool, based on failure rate, repair rate, and cost of work. The formula for calculating the total maintenance costs for any single cost component in year i is

$$M_i = (M_1 + M_2)_i = \frac{V_{i-1} + V_i}{2} \left(P_i \cdot R_{class} + P_l \cdot \frac{MTTR}{MTBR} \right), \quad (5.1)$$

where

- V_i is the equipment volume in year i ,
- P_i is the price of the cost component in year i ,
- R_{class} is the maintenance cost percentage,
- P_l is the cost of a work hour (EUR/hour),
- MTTR is the mean time to repair for the cost component (hours), and
- MTBR is the mean time between repairs for the cost component (hours).

O&A represents operation and administration costs that have to be included manually when building models. The O&A costs are typically dependent on the number of customers and number of critical network elements. (Olsen 1999)

5.4.7 Risk analyses

The TERA tool does not have in-built tools for risk or sensitivity analyses. The tool has been modified to enable simulation analyses using a commercial risk assessment tool package Crystal Ball[®], which is an add-in to Microsoft Excel[®] and allows Monte Carlo simulations to be run. The Crystal Ball[®] tool was not used in this thesis.

5.5 Chapter summary

In the chapter, an introduction to the techno-economic analyses of broadband access networks was given. Much of the related methodology and models have been created during the past decade in several European R&D projects. The work carried out in these projects gives a good basis for the analyses carried out in the thesis. Furthermore, an Excel-based software tool developed in these projects will be used in the thesis.

The chapter introduced the required inputs to and outputs from the techno-economic analyses. Sensitivity analyses were recognized as an essential part of the process, giving insight into the most important parameters behind the “hard” results and figures.

6 Economic analysis of FWA networks

In Chapters 3 and 4, the technologies and planning methods of FWA networks were discussed. In Chapter 5, an overview of techno-economic analyses of broadband access networks was given. The purpose of this chapter is to apply and summarize the information and methods of the previous chapters, and to analyze the economic aspects of FWA network deployments in different kind of environments.

The chapter strives to answer the following broad questions:

- Is FWA a threat to established operators?
 - Are new entrants able to cost-effectively build and operate a FWA network in different environments?
 - Are FWA networks likely to become the technology of choice for new entrants, instead of DSL over leased lines?
- Is FWA a possibility to established operators?
 - What are the most attractive environments for FWA?
 - Could FWA networks be used to provide broadband services more cost-efficiently than with DSL technologies, e.g. in sparsely populated areas?

The analysis in this chapter follows the framework introduced in Chapter 5, and uses the capabilities of the TERA techno-economic tool. The analysis consists of the following five stages:

- First, the scenarios and assumptions used as inputs to the analysis are introduced.
- Second, the network dimensioning methods introduced in Chapter 4 are used to find out the numbers of network components required to fulfill the coverage and capacity demands of the input scenarios.
- Third, the economic analyses are carried out using the TERA tool.
- Fourth, a sensitivity analysis is performed on the key variables of the analyses.
- Finally, the results and findings from the analyses are summed up and discussed.

These five stages are carried out and presented in the following five sections, respectively.

6.1 Input scenarios

The framework proposed by Ravera et al. (1998) is used to construct the input scenarios for the techno-economic analysis.

6.1.1 Study period

The analysis is made for a study period of 5 years, spanning from 2004 to 2008. In the input data tables the scenario attributes reflect the situation in the ends of the respective years. Therefore, also the situation in the end of the year 2003 is shown in each table.

The FWA network is assumed to be launched in the beginning of the year 2004. The coverage area of the network is assumed to be 0% of the service area in 31.12.2003, and 100% in 1.1.2004.

6.1.2 Environmental scenarios

The analysis is made for six different types of areas, or environmental scenarios:

- two urban areas,
- two suburban areas, and
- two rural areas.

Each of the scenarios is characterized by e.g. their geographic areas and household densities. Data on Finnish municipalities has been used as a base in forming the scenarios (see Appendix A.4).

Table 6.1 shows the attributes of the environmental scenarios. The scenarios were deliberately constructed so that in each scenario, the achievable number of subscribers would be roughly the same, taking into account also the expected market share evolution in each environment. In each case, the expected number of subscribers in the end of the study period is about 1600.

Table 6.1: Attributes of environmental scenarios

Scenario	Geographic area (L x L = A km ²)	Household density (1/km ²)	Number of households	Number of telephone exchanges in the area
Urban area I	2 x 2 = 4	5000	20000	2
Urban area II	3.16 x 3.16 = 10	2000	20000	2
Suburban area I	3.74 x 3.74 = 14	1000	14000	2
Suburban area II	5.29 x 5.29 = 28	500	14000	2
Rural area I	31.6 x 31.6 = 1000	5	5000	16
Rural area II	50 x 50 = 2500	2	5000	36

6.1.3 Service scenarios

The services to be offered are limited to high-speed Internet access subscriptions at various data rates. Data on the penetrations of personal computers (PCs), Internet subscriptions, and broadband Internet subscriptions (as shown in Figure 1.1) was used as a basis for the prediction of service penetration. The prediction was made using the following trends as assumptions:

- The penetration of personal computers in households will continue to increase steadily 4 percentage points per year throughout the study period.
- The penetration of Internet connections (both narrowband and broadband) will continue to increase steadily 5 percentage points per year throughout the study period.
- The proportion of broadband subscriptions out of all Internet subscriptions will increase heavily. It will reach 76 percent (1000.000 households) in the end of 2005 and 86 percent in the end of 2008.

The predicted service penetration evolution is shown in Figure 6.1.

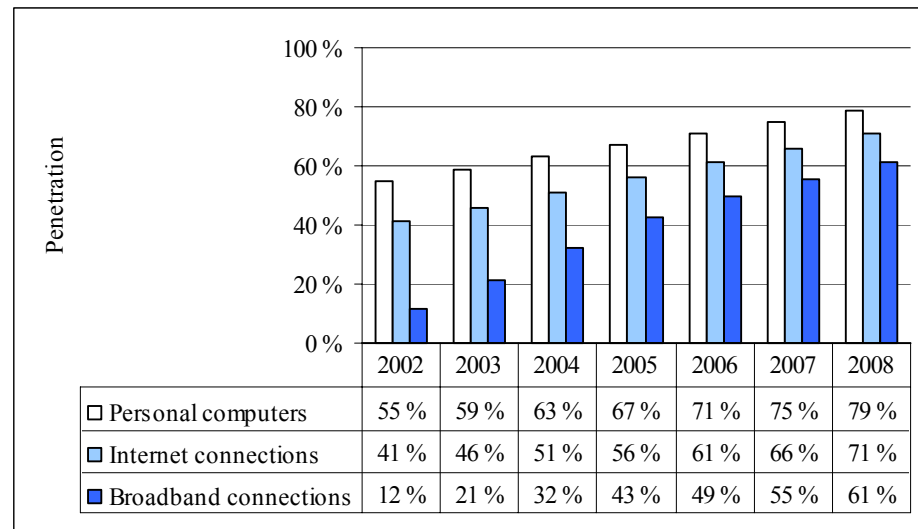

Figure 6.1: Predicted broadband penetration

It should be noted that the predicted broadband penetration is somewhat higher than figures predicted in various analyst reports published in the past few years. Since the beginning of the year 2003 the penetration of broadband subscriptions has grown faster than any published analyst reports have predicted. Therefore, an own prediction was seen necessary in the thesis.

The predicted broadband access penetration figure is further segmented into a number of throughput classes in order to derive the requirements for network capacity planning. For the purposes of this thesis, four different classes are used, with downstream throughputs spanning from 256 kbps up to 2 Mbps. Also, a fifth class representing the higher throughputs is defined. Figure 6.2 shows the predicted penetration of different throughput classes.

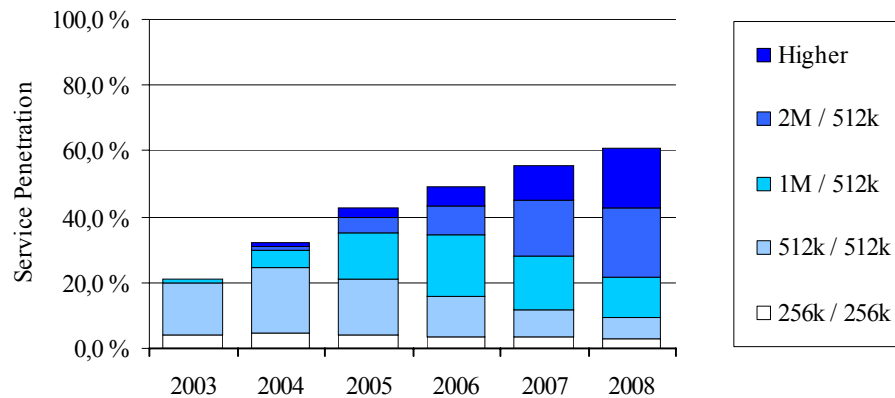

Figure 6.2: Predicted broadband penetration, by throughput class

As discussed in Chapter 4, the average capacity of a single 3.5 GHz FWA sector with channel bandwidth of 7 MHz can be assumed to be 15 Mbps. This means that a relatively low number of subscribers with subscriptions to throughput classes higher than 2M / 512k can congest a single sector quite easily. In the thesis, it is assumed that with FWA systems the 2M / 512k throughput class is the highest one to be offered to the subscribers.

In order to calculate the annual revenues for the broadband access network investment, tariffs for the services have to be specified. In Finland, the tariffs for broadband services have decreased during 2003 as shown in Table 6.2.

Table 6.2: Average monthly ADSL subscription fees in Finland, VAT incl. (Source: Kangas 2004)

Throughput class	1.1.2003	1.10.2003	Change
256 kbps / 256 kbps (€ / month)	50.32	44.00	-13 %
512 kbps / 512 kbps (€ / month)	64.16	49.04	-24 %
1 Mbps / 512 kbps (€ / month)	103.18	62.00	-40 %
2 Mbps / 512 kbps (€ / month)	-	102.36	-
4 Mbps / 512 kbps (€ / month)	-	299.00	-
Installation fee (€)	152.84	129.91	-15 %

In the future, the tariffs are assumed to decrease further. In throughput classes of up to 1M / 512k, the monthly tariffs are assumed to decrease 10 % each year. In the 2M / 512k and higher throughput classes the price reductions are assumed to be faster, i.e. 15% and 25%, respectively. The installation fees are assumed to decrease 10% yearly. Figure 6.3 illustrates the predicted annual tariffs based on these assumptions.

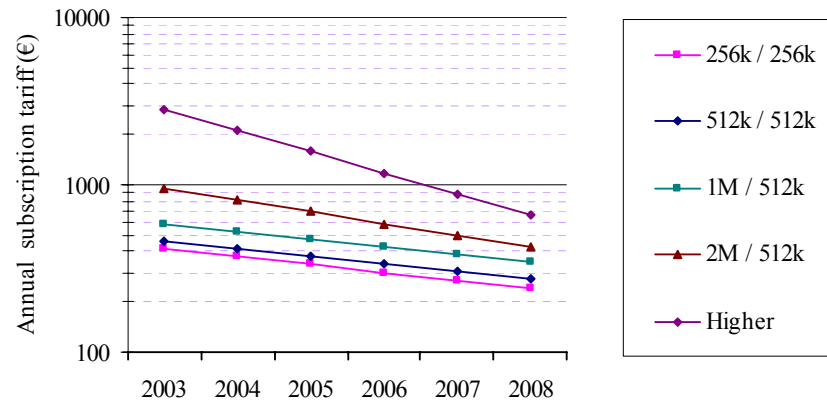

Figure 6.3: Predicted annual broadband access tariffs (VAT excl.)

The broadband subscription fees charged from the consumers, excluding the VAT of 22%, are shared between the service operator and the network operator. In order to calculate the network operator profits, the revenue sharing ratio between the two has to be known. ADSL service tariffs can be used as a basis for defining this ratio.

As discussed earlier, SMP operators are obliged to publish the delivery terms and tariff information related to their services. A quick view on some public price lists of Finnish network operators (e.g. TeliaSonera 2004, Oulun Puhelin 2004) reveals that a network operator selling bitstream access services to a service operator gets a 60% - 95% share of the subscription fees. The actual figure depends e.g. on the throughput class and the number of subscribers in the area. In the thesis, the network operator share of the subscriber fees is assumed to be 80% throughout the study period. Using this, the network operator tariffs are calculated in Table 6.3.

Table 6.3: Predicted annual tariffs for network services, VAT excl.

Service	2003	2004	2005	2006	2007	2008
Installation fee	97.50	87.75	78.98	71.08	63.97	57.57
256k / 256k	329.47	296.52	266.87	240.19	216.17	194.55
512k / 512k	366.91	330.22	297.20	267.48	240.73	216.66
1M / 512k	464.26	417.83	376.05	338.44	304.60	274.14
2M / 512k	763.78	649.21	551.83	469.05	398.70	338.89

The rental fee of ADSL modems and FWA CPEs are included to the tariffs of Table 6.3.

6.1.4 Regulatory scenarios

In each of the environmental scenarios introduced above, the competitive situation in the market is assumed to be different, as follows:

- In the urban areas the new entrant has four competitors (3 x DSL + 1 x cable).
- In the suburban areas the new entrant has three competitors (2 x DSL + 1 cable), of which the cable network operator serves 50% of households in the areas.
- In the rural areas the new entrant has only one competitor (DSL) that serves 70% of households in the areas.

The predicted broadband penetration serves as the basis for the market share predictions. All the operators active in a certain area are assumed to be equally strong in competition of new broadband subscribers, and the number of new subscribers is assumed to divide equally among the operators. The number of subscribers changing their operator is also assumed to be the same in all directions, so that each operator wins and loses an equal amount of existing subscribers.

In the rural areas, the FWA operator is assumed to win all the new customers from areas not served by the DSL operator. In suburban areas, the FWA operator has two competitors for half of the households, and three competitors for the other half.

The FWA operator is not able to offer subscriptions to throughput classes higher than 2M / 512k. For simplicity, however, the market share of the FWA operator is not expected to suffer due to this. The FWA operator is assumed to be equally strong as others in competition of all the customers.

Using these assumptions, the market share of the FWA operator in different areas can be calculated to evolve in the following way during the study period.

Table 6.4: Market share of the FWA operator

	2003	2004	2005	2006	2007	2008
Urban area I & II	0.00 %	6.78 %	10.02 %	11.40 %	12.34 %	13.04 %
Suburban area I & II	0.00 %	9.89 %	14.61 %	16.63 %	17.99 %	19.02 %
Rural area I & II	0.00 %	41.86 %	47.53 %	49.95 %	51.59 %	52.82 %

6.1.5 Technology scenarios

A main task in the thesis is to compare the FWA systems to ADSL systems from the point of view of a new entrant, i.e. an operator that does not have its own network infrastructure in the service area. Technology scenarios for both the ADSL and FWA systems are shown in Figure 6.4.

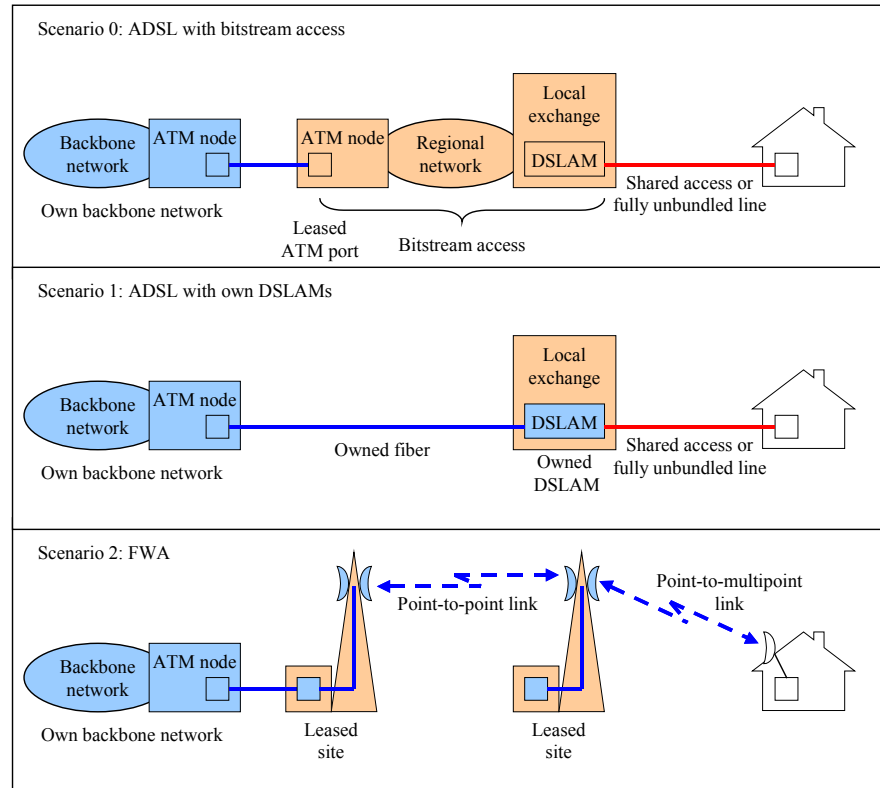

Figure 6.4: Technology scenarios

In scenarios 0 and 1, two different possibilities to utilize the incumbent operator's telephone network infrastructure are shown, i.e. ADSL with bitstream access and ADSL with own DSLAMs. In both of the scenarios, the subscriber lines have to be leased from the incumbent.

In scenario 0, the incumbent owns also the DSLAMs. The bitstream access service is delivered over the incumbent's regional network and handed over to the new entrant operator in a suitable ATM node that is then interconnected to the new entrant's backbone network. In scenario 1, the new entrant takes its own DSLAMs to the incumbent's premises and connects them to the backbone network by bringing its own fiber to the premises. Scenario 0 is included in the figure just to illustrate the bitstream

access service possibility; it is not included in the actual calculations. The prices of bitstream access services are high, and as the subscriber base of the new entrant grows, it quickly becomes more profitable to build own DSLAMs.

In scenario 2, the new entrant bypasses the incumbent's network infrastructure by building its own access network using FWA systems. The required antenna sites are leased from local site owners. The connections between the FWA base stations and the backbone network are built using point-to-point microwave radio links.

In the technology scenarios, a number of cost components are assigned to different parts of the networks. The price evolution of these components is calculated by the TERA tool according to the extended learning curve model introduced in Section 5.4.5. For the model, an initial price reflecting the situation in the beginning of year 2004 is given to each component. The future price evolution is determined by assigning each component to a certain volume class defining the maturity and growth speed of the technology. The required components and their prices over the study period are listed in Table 6.5.

Table 6.5: Network components and their price evolution

Network component	Price unit	Maturity class	Growth speed	2004	2005	2006	2007	2008
Fiber cable cost, urban area	€ / km	-	-	60000	60000	60000	60000	60000
Fiber cable cost, suburban area	€ / km	-	-	30000	30000	30000	30000	30000
Fiber cable cost, rural area	€ / km	-	-	10000	10000	10000	10000	10000
DSLAM (max. 16 x 64 ports)	€	Mature	Fast	3000	2359	1933	1678	1543
64-port ADSL line card	€	Mature	Fast	3200	2516	2062	1790	1646
Mini-DSLAM (32 ports)	€	Mature	Fast	3200	2516	2062	1790	1646
ADSL CPE	€	Mature	Fast	50	39	32	28	26
FWA BS equipment	€	New	Fast	30000	22709	17295	13352	10595
FWA sector radio transceiver	€	New	Fast	2000	1514	1153	890	706
FWA sector antenna	€	Mature	Medium	1000	883	786	707	644
Point-to-point radio link	€ / link	Mature	Medium	40000	35329	31449	28286	25770
FWA CPE with outdoor antenna	€	New	Fast	750	568	432	334	265
FWA CPE with indoor antenna	€	New	Fast	500	378	288	223	177

Fiber cable cost includes the cost of the cables and ducts, as well as the civil works including digging, trenching, and repairing of roads and pavements. The cost of fiber cable depends on the area: in urban and suburban areas there are more roads and pavements to be dug and repaired, leading to higher cost than in rural areas.

Two different kinds of DSLAMs are considered. The bigger one is suited for high-density areas and provides a maximum of $16 \times 64 = 1024$ ports for individual subscribers. Capacity of the bigger DSLAM can be increased by installing 64-port line cards as the subscriber base grows. The mini-DSLAM has 32 ports and can be used in

areas with lower density of subscribers. Multiple mini-DSLAMs can be stacked together, making it possible to aggregate their traffic to a single backbone connection.

The ADSL CPE is a low-cost ADSL modem with a standard 10/100BaseT interface.

FWA base station equipment multiplexes the traffic from multiple sectors and provides an interface to the backbone network. For each sector, a radio transceiver module and a sector antenna is also required. The backbone connection can be provided with a point-to-point radio link or a fiber cable, and can be either IP or ATM-based.

Two different types of FWA CPEs are assumed to be available. The first type includes a separate directional outdoor antenna, whereas the second type has an integrated omnidirectional antenna. The CPE with an indoor antenna can be installed by the customers themselves, whereas the outdoor antenna requires a technician to install it.

Point-to-point radio links are used to connect the FWA base stations to the backbone network. A 155 Mbps radio link is capable of providing the transmission for one 6-sector base station ($6 \times 15 \text{ Mbps} = 90 \text{ Mbps}$). A single radio link consists of two radio transceivers and directional antennas.

In addition to the network components, OA&M costs have to be included in the calculations analyses. As discussed in Chapter 5, TERA tool automatically calculates the maintenance costs based on the cumulative network investments, MTTR and MTBR figures of the components, and cost of labor, which is assumed to be 50 €/hour for the whole study period. The operation and administration costs, however, have to be added separately. These are shown in Table 6.6.

Table 6.6: Operation and administration costs

O&A cost component	Price unit	2003-2008
Cost of labor	€/ hour	50
DSLAM site rental	€/ year	600
DSLAM installation cost	€	1000
Mini-DSLAM installation cost	€	200
Subscriber line, installation fee	€/ subscriber	150
Subscriber line, rental	€/ subscriber / year	100
Radio link antenna site rental	€/ year / link	1200
FWA spectrum fee	€/ year / km ²	7
FWA BS site rental, incl. electricity	€/ year	600
FWA BS installation cost	€	3000
FWA sector antenna site rental	€/ year	600
FWA CPE installation cost	€	150

As shown in Table 6.6, the O&A costs included in the analyses consist mostly of the installation costs and rental fees of the equipment. Costs related to e.g. network management systems, administration, and provisioning are not included in the analysis. These are expected to be similar between ADSL and FWA systems, not having significant effect on the comparative calculations.

6.1.6 Economic inputs

For the NPV calculations a discount factor of 15% is used, reflecting the comparatively high risks involved.

A straight-line depreciation method, i.e. one in which the depreciations of an investment are equally large each year, is used with the following depreciation times:

- 20 years for fiber cable
- 5 years for DSLAMs, FWA base stations and sectors, and software licenses
- 3 years for ADSL modems and FWA CPEs

Corporate tax rate of 29% was used, which corresponds to the current situation in Finland. Losses are deductible from taxes for five years.

6.2 FWA network dimensioning

In this section, network dimensioning and planning methods introduced in Chapter 4 are used to find the number of FWA base stations and sectors required in each environment.

6.2.1 Capacity planning

The traffic demands of broadband subscribers are expected to grow steadily throughout the study period. This is reflected also on the penetrations of different throughput classes, as was shown in Figure 6.2. Using the service penetration figures as a basis, the evolution of the average throughput demand is calculated in Table 6.7. It should be noted that these figures are not related to the actual traffic transmitted in the network, but the averages of the throughput classes the subscribers belong to. In the table, the upstream and downstream throughputs are added together.

Table 6.7: Average throughput demand of subscribers

	2003	2004	2005	2006	2007	2008
Average throughput (kbps)	977,92	1152,00	1402,88	1643,52	1899,52	2099,20

As discussed in Chapter 4, provided that the traffic of the subscribers is bursty, statistical multiplexing can be utilized. A decision has to be made on a proper concentration factor to be used. In the thesis, a concentration factor of 10 is expected to be sufficiently low throughout the study period.

Calculation of the required number of FWA base stations and sectors is shown in Table 6.8 for urban areas. Results for all the areas are shown in Table 6.9.

Table 6.8: Number of FWA sectors and base stations required in the urban areas

	2003	2004	2005	2006	2007	2008
Total number of households	20000					
Broadband penetration	21.24 %	32.13 %	42.56 %	49.41 %	55.44 %	61.06 %
FWA operator market share	0.00 %	6.78 %	10.02 %	11.40 %	12.34 %	13.04 %
FWA subscribers	0	436	853	1127	1368	1593
Average throughput (kbps)	977.92	1152.00	1402.88	1643.52	1899.52	2099.20
Concentration factor	10					
Aggregate capacity demand in the area (Mbps)	0	50.18	119.64	185.19	259.85	334.36
FWA sector capacity (Mbps)	15					
Number of FWA sectors	0	4	8	13	18	23
FWA sectors per base station	6					
Number of FWA base stations	0	1	2	2	3	4

Table 6.9: Capacity planning results

	2003	2004	2005	2006	2007	2008
FWA sectors						
Urban area I	0	4	8	13	18	23
Urban area II	0	4	8	13	18	23
Suburban area I	0	4	9	13	18	23
Suburban area II	0	4	9	13	18	23
Rural area I	0	6	10	14	19	23
Rural area II	0	6	10	14	19	23
FWA base stations						
Urban area I	0	1	2	3	3	4
Urban area II	0	1	2	3	3	4
Suburban area I	0	1	2	3	3	4
Suburban area II	0	1	2	3	3	4
Rural area I	0	1	2	3	4	4
Rural area II	0	1	2	3	4	4

The similarity of the capacity planning results is due to the choice of selecting the geographical areas of the environmental scenarios so that the number of subscribers would be the same in the end of the study period, i.e. about 1600.

6.2.2 Coverage planning

As the results from the capacity planning process show, the capacity-based number of FWA base stations required in each area is 4 in the end of the study period. The

objective of the coverage planning is to calculate coverage-based number of base stations for each area. The number of base stations to be built is the higher of the two.

The optimal way to cover a square-shaped service area with 4 equally sized cells is shown in Figure 6.5. The cell radius r can be calculated to be $(1/4)*\sqrt{2}*L$. More generally, the cell radius in case of n^2 cells can be calculated to be $(1/(2n))*\sqrt{2}*L$.

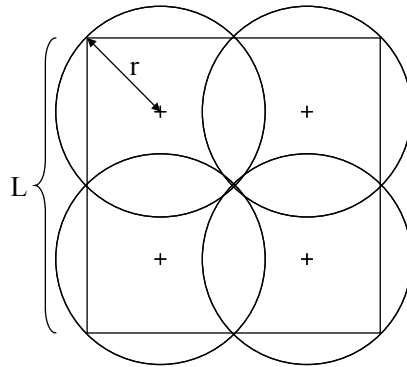

Figure 6.5: Four cells covering a square-shaped area

Using this approach, the required cell ranges for different numbers of cells are calculated in Table 6.10.

Table 6.10: Required range of FWA base stations

Scenario	Area (km ²)	L (km)	r (km), 1 cells	r (km), 4 cells	r (km), 9 cells	r (km), 16 cells	r (km), 25 cells	r (km), 36 cells
Urban area I	4	2.00	1.41	0.71	0.47	0.35	0.28	0.24
Urban area II	10	3.16	2.24	1.12	0.75	0.56	0.45	0.37
Suburban area I	14	3.74	2.65	1.32	0.88	0.66	0.53	0.44
Suburban area II	28	5.29	3.74	1.87	1.25	0.94	0.75	0.62
Rural area I	1000	31.62	22.36	11.18	7.45	5.59	4.47	3.73
Rural area II	2500	50.00	35.36	17.68	11.79	8.84	7.07	5.89

In the urban and suburban area scenarios, the capacity-based number of four base stations gives range requirements of 0.71 – 1.87 km. In the rural areas, the range requirements are substantially higher, 11.18 and 17.68 km. Based on the calculations carried out in Chapter 4, it seems that this kind of performance is not going to be achieved in real deployments. Instead, in many cases, the FWA base stations are going to be coverage-limited, i.e. the number of base station is higher than would be required based on capacity demands.

In Chapter 4, the achievable ranges were estimated to be 1.5 / 0.5 km for suburban and urban areas using outdoor / indoor CPE antennas, and 10 km for rural areas. Using these

numbers as a basis, the required number of base stations can be calculated for each area. Table 6.11 summarizes the coverage planning results and shows the number of FWA cells to be implemented in each area.

Table 6.11: Coverage planning results

Scenario	FWA CPE type	Required number of base stations
Urban area I	Outdoor CPE	1
	Indoor CPE	9
Urban area II	Outdoor CPE	4
	Indoor CPE	25
Suburban area I	Outdoor CPE	4
Suburban area II	Outdoor CPE	9
Rural area I	Outdoor CPE	9
Rural area II	Outdoor CPE	16

Based on the coverage planning results, it is obvious that a network deployment based on the assumption of indoor CPEs is very expensive in areas other than the densely populated Urban area I. Already in Urban area II, 25 cells are required for indoor CPE deployment. For suburban and rural areas only outdoor CPEs are considered relevant.

6.2.3 FWA network shopping lists

Based on the capacity and coverage planning results, shopping list can be constructed for each of the service areas, as shown in Table 6.12 and 6.13. A minimum number of three sectors per FWA base station is assumed.

Table 6.12: FWA network shopping list, urban areas

	2003	2004	2005	2006	2007	2008
Urban area I						
<i>Case 1: Outdoor CPEs</i>						
Point-to-point radio link	0	1	2	3	4	4
FWA base station	0	1	2	3	4	4
FWA sector radio transceiver	0	4	8	13	18	23
FWA sector antenna	0	4	8	13	18	23
FWA CPE with outdoor antenna	0	436	853	1127	1368	1593
<i>Case 2: Indoor CPEs</i>						
Point-to-point radio link	0	9	9	9	9	9
FWA base station	0	9	9	9	9	9
FWA sector radio transceiver	0	27	27	27	27	27
FWA sector antenna	0	27	27	27	27	27
FWA CPE with indoor antenna	0	436	853	1127	1368	1593
Urban area II						
<i>Case 1: Outdoor CPEs</i>						
Point-to-point radio link	0	4	4	4	4	4
FWA base station	0	4	4	4	4	4
FWA sector radio transceiver	0	12	12	13	18	23
FWA sector antenna	0	12	12	13	18	23
FWA CPE with outdoor antenna	0	436	853	1127	1368	1593
<i>Case 2: Indoor CPEs</i>						
Point-to-point radio link	0	25	25	25	25	25
FWA base station	0	25	25	25	25	25
FWA sector radio transceiver	0	75	75	75	75	75
FWA sector antenna	0	75	75	75	75	75
FWA CPE with indoor antenna	0	436	853	1127	1368	1593

Table 6.13: FWA network shopping list, suburban and rural areas

Suburban area I						
Point-to-point radio link	0	4	4	4	4	4
FWA base station	0	4	4	4	4	4
FWA sector radio transceiver	0	12	12	13	18	23
FWA sector antenna	0	12	12	13	18	23
FWA CPE with outdoor antenna	0	445	871	1150	1396	1626
Suburban area II						
Point-to-point radio link	0	9	9	9	9	9
FWA base station	0	9	9	9	9	9
FWA sector radio transceiver	0	27	27	27	27	27
FWA sector antenna	0	27	27	27	27	27
FWA CPE with outdoor antenna	0	445	871	1150	1396	1626
Rural area I						
Point-to-point radio link	0	9	9	9	9	9
FWA base station	0	9	9	9	9	9
FWA sector radio transceiver	0	27	27	27	27	27
FWA sector antenna	0	27	27	27	27	27
FWA CPE with outdoor antenna	0	673	1011	1234	1430	1613
Rural area II						
Point-to-point radio link	0	16	16	16	16	16
FWA base station	0	16	16	16	16	16
FWA sector radio transceiver	0	48	48	48	48	48
FWA sector antenna	0	48	48	48	48	48
FWA CPE with outdoor antenna	0	673	1011	1234	1430	1613

6.3 ADSL network dimensioning

To compare the FWA network deployments to ADSL networks in the different environments, ADSL network dimensioning has to be carried out.

The telephone exchanges and exchange areas of the traditional PSTN networks form the basis for ADSL network dimensioning. DSLAMs are co-located in the telephone exchanges of local fixed line operators, terminating the subscriber line connections from all the households in the exchange area. Based on the capacity requirements of the area, a sufficient number of DSLAMs and DSL line cards have to be installed.

As discussed earlier, two different types of DSLAMs are assumed to be used: The larger DSLAMs consist of a chassis and a number of ADSL line cards capable of serving 64 subscribers. A maximum of 16 line cards can be fitted in one chassis, providing connections to 1024 subscribers. The mini-DSLAMs, on the other hand, are capable of serving 32 subscribers. Mini-DSLAMs can be stacked together, and their traffic aggregated to a single backbone connection. The larger DSLAMs are used in urban and suburban areas, whereas in rural areas, mini-DSLAMs are used.

The backbone connections to DSLAMs are provided by bringing an own fiber cable to the local operator's exchange premises. The cost of the fiber cable depends on its length

as well as the area where it is built. The required length s of fiber cable is calculated based on Figure 6.6, showing the exchange areas and the fiber cable together with its endpoints.

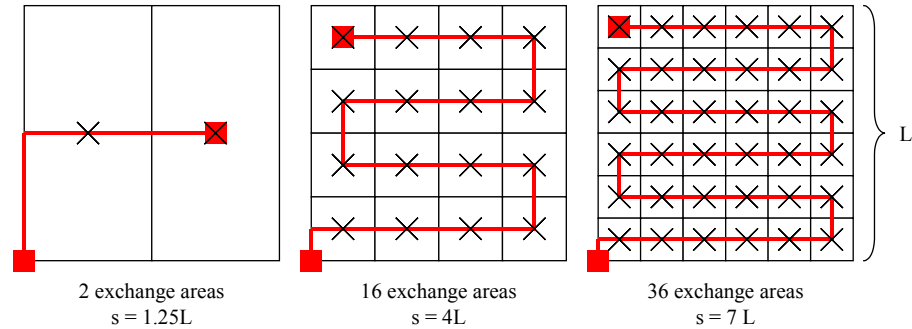

Figure 6.6: Fiber backbone network dimensioning

6.3.1 ADSL network shopping list

As a conclusion, the ADSL network deployment schedule is shown in Table 6.14.

Table 6.14: ADSL network shopping list

	2003	2004	2005	2006	2007	2008
Urban area I						
DSLAMs	0	2	2	2	2	2
64-port ADSL line cards	0	7	14	18	22	25
Fiber cable (km)	0	2.5	2.5	2.5	2.5	2.5
ADSL modems	0	436	853	1127	1368	1593
Urban area II						
DSLAMs	0	2	2	2	2	2
64-port ADSL line cards	0	7	14	18	22	25
Fiber cable (km)	0	3.95	3.95	3.95	3.95	3.95
ADSL modems	0	436	853	1127	1368	1593
Suburban area I						
DSLAMs	0	2	2	2	2	2
64-port ADSL line cards	0	7	14	18	22	26
Fiber cable (km)	0	4.68	4.68	4.68	4.68	4.68
ADSL modems	0	445	871	1150	1396	1626
Suburban area II						
DSLAMs	0	2	2	2	2	2
64-port ADSL line cards	0	7	14	18	22	26
Fiber cable (km)	0	6.61	6.61	6.61	6.61	6.61
ADSL modems	0	445	871	1150	1396	1626
Rural area I						
Mini-DSLAMs	0	22	32	39	45	51
Fiber cable (km)	0	126.49	126.49	126.49	126.49	126.49
ADSL modems	0	673	1011	1234	1430	1613
Rural area II						
Mini-DSLAMs	0	36	36	39	45	51
Fiber cable (km)	0	350	350	350	350	350
ADSL modems	0	673	1011	1234	1430	1613

6.4 Economic analysis

Using the predictions and assumptions introduced in the past three sections, the economic analyses can be carried out for different scenarios. Using the TERA tool, the calculations are quite straightforward, yielding the results shown in Figure 6.7.

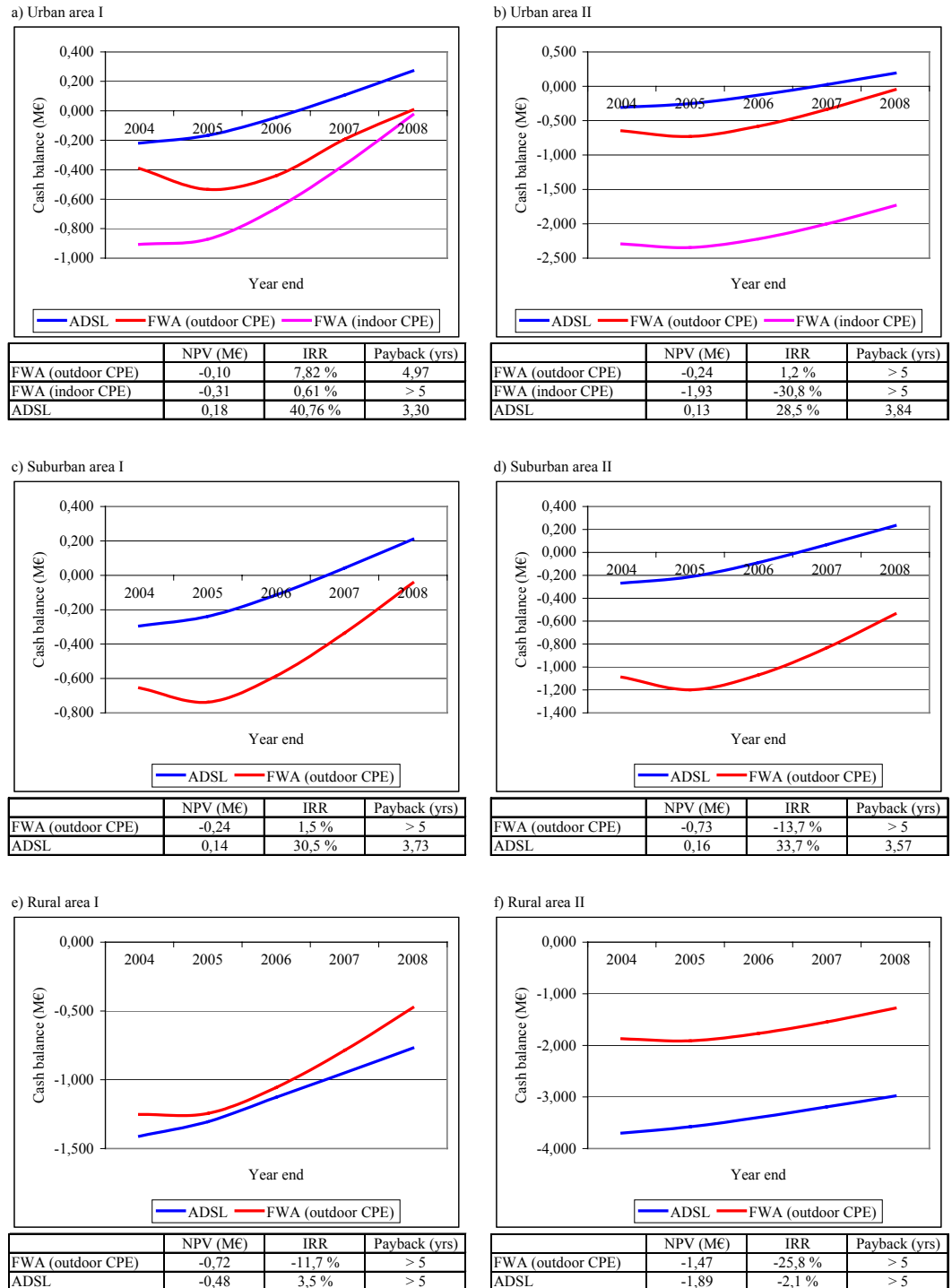

Figure 6.7: Results from economic analysis (Note: The y-scales differ between figures)

In the figure, a cash balance curve as well as values of NPV, IRR, and payback time are shown for both FWA and ADSL networks in each scenario. Payback times are not calculated if they are higher than 5 years.

6.4.1 Economic feasibility of FWA in different scenarios

Based on the results depicted in Figure 6.7, FWA networks do not seem to be economically feasible in providing broadband Internet access to households, at least under the scenarios and assumptions made in previous sections. In all the scenarios, the NPV figures of FWA network projects are more or less negative. Also, in all cases but one the payback times of the projects are longer than the study period of 5 years.

The outcome of FWA network projects is better in more densely populated areas. As the household density decreases, the profitability of FWA deployment weakens. This results from the fact that FWA networks become coverage-limited. Only in the Urban area I scenario the network is capacity-limited, yielding the best NPV, IRR, and payback figures.

6.4.2 Revenue and investment breakdowns

The revenue breakdown is calculated as a product of the service tariffs and the numbers of subscribers to different throughput classes. Revenue breakdown for the Urban area I scenario is shown in Figure 6.8. In other scenarios the breakdown is almost identical.

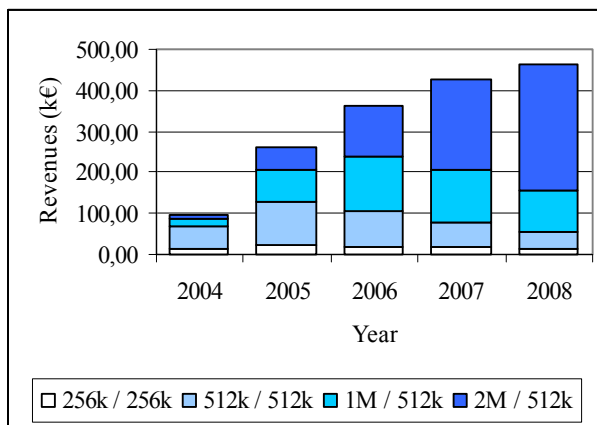

Figure 6.8: Breakdown of revenues (Urban area I)

The revenue breakdown highlights the move towards higher throughput classes. As service tariffs decrease and subscriber demand for throughput increases, the future

revenues are expected to come from higher and higher throughput classes. The average revenue per subscriber, however, is not likely to increase. Instead, higher throughput classes will be subscribed to with the same price.

Similarly, the breakdown of investments is shown in Figure 6.9 for two different scenarios.

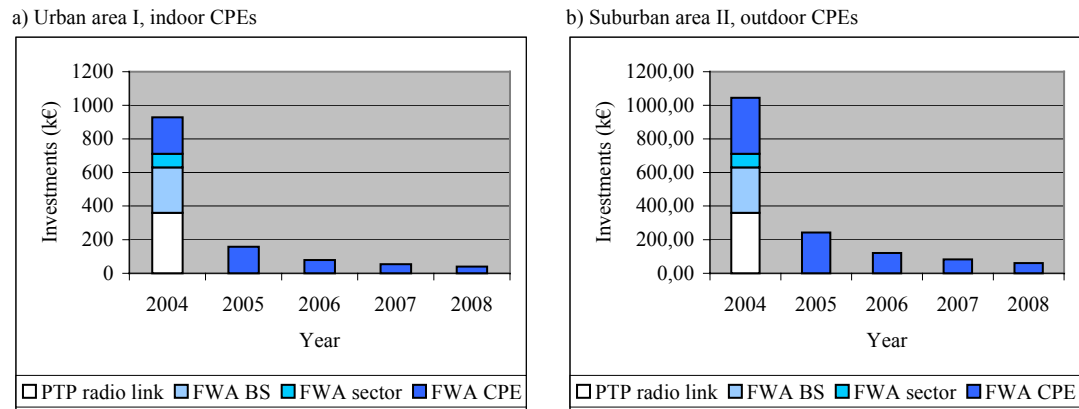

Figure 6.9: Breakdown of investments

Because of the coverage-limited nature of the networks, the majority of the network investments take place in the first year. The number of FWA base stations and sectors that are initially built to cover the service area are enough to provide the required capacity for the future subscribers, also.

As the investment breakdown shows, the base station and sector equipment are not the biggest investment items in the FWA network deployment. Instead, the investments are dominated by the expensive FWA CPEs. The cost of backbone connections (i.e. radio links) is also significant.

6.4.3 FWA vs. ADSL

Figure 6.7 shows that FWA networks are not competitive against ADSL in urban or suburban areas. In these areas, the number of households that can be attached to a single DSLAM is sufficiently high, making the ADSL solution very cost-effective. Also, the cost of providing a fiber-based backbone connection is sufficiently low because of the small geographical area.

In rural areas, however, FWA networks seem to be competitive against ADSL. As the household density decreases, the number of subscribers per DSLAM gets smaller. A single FWA base station can serve a larger base of subscribers than a single DSLAM, giving cost savings on the equipment and backbone connection.

It should be noted, however, that although FWA seems to beat ADSL in rural areas, both solutions are highly unprofitable. Furthermore, in the ADSL case a future-proof fiber backbone is built to the telephone exchange areas, which is of significantly higher value in the long term than the backbone radio links of a FWA system.

6.4.4 User-installable CPEs

Based on the results shown in Figure 6.7 a and b, user-installable indoor CPEs may become a feasible alternative only on the most densely populated areas. As discussed in Chapter 4, in the case of indoor CPEs the range of the FWA base stations decreases significantly, to about a third of the range in the case of outdoor CPEs. This increases the required number of base stations with a factor of nine, ruining the profitability in most cases. Because in most cases the FWA networks are already coverage-limited when using outdoor CPEs, the use of indoor CPEs is not feasible.

6.5 Sensitivity analysis

Based on the results and hard figures presented on the previous section, one could already state that FWA networks are not an economically feasible solution for the residential broadband market. To get a deeper insight to the most critical parameters behind the results, sensitivity analyses are carried out.

Figure 6.10 shows the sensitivity charts for broadband penetration, service tariffs, and FWA CPE cost. Table 6.15 shows the calculated slopes of the curves in the sensitivity graphs.

Among other things, the sensitivity graphs show the required change in the key parameters in order to turn the NPV of the projects positive. For example, in the Urban area I with outdoor CPEs, the CPE cost should be about 20% lower throughout the study period in order to reach positive NPV. On the other hand, service tariff increase of about 12% would give a similar outcome.

a) Urban area I, outdoor CPEs

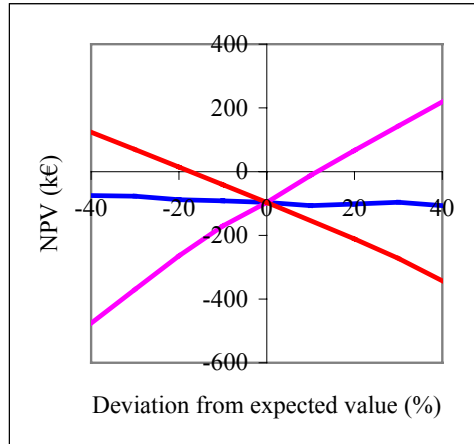

b) Urban area I, indoor CPEs

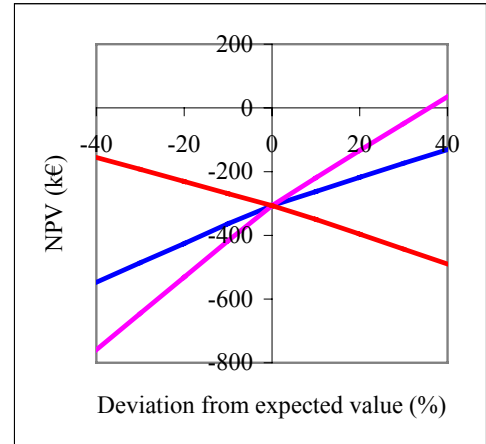

c) Suburban area I, outdoor CPEs

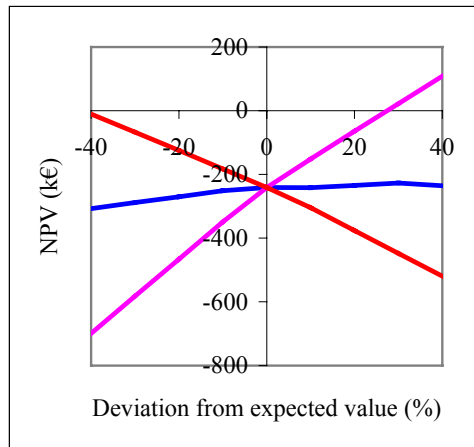

d) Rural area I, outdoor CPEs

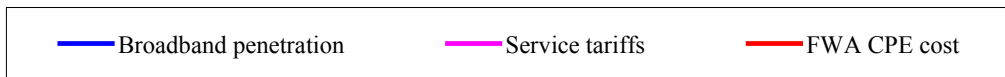
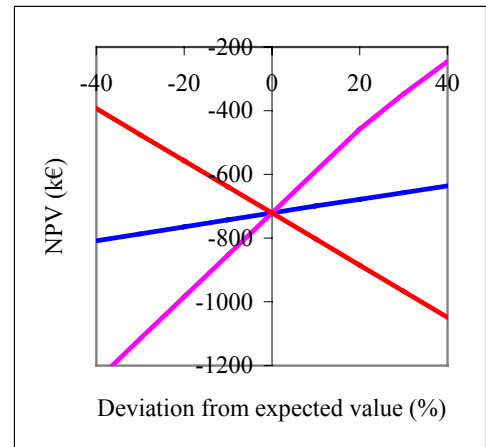

Figure 6.10: Sensitivity graph for broadband penetration, service tariffs, and FWA CPE cost

Table 6.15: Sensitivity graph curve slopes (k€ / D)

	Broadband penetration	Service tariffs	FWA CPE cost
Urban area I, outdoor CPEs	-0,38	8,57	-5,76
Urban area I, indoor CPEs	5,20	9,94	-4,17
Suburban area I	0,92	10,08	-6,34
Rural area I	2,16	12,73	-8,20

The curve slopes show the elasticity of the NPV value to changes in the key parameters. For example, the slopes of the service tariff curves vary between 8.57 and 12.73 k€ / D, where D is the deviation from expected value in percentage. This means that if

the service tariffs increased by 10%, the NPV figures of the cases would be 85.7 – 127.3 k€ higher.

NPV sensitivity to changes in the FWA CPE cost varies between –4.17 and –8.20 k€ / D. As could be expected, the sensitivity is at its lowest when using lower-priced indoor CPEs. The sensitivity can be considered to be quite low, at least when compared with sensitivity to service tariffs.

NPV sensitivity to changes in the broadband penetration acts very interestingly in different cases. In some cases (b & d) the sensitivity is clearly positive, but in other cases (a & c) the NPV seems to be somewhat indifferent to changes in the penetration.

The reason behind this is simple. In Urban area I with outdoor CPEs (a) the network is capacity-limited. Therefore, as the number of subscribers grows, new base stations and sectors have to be built, diminishing the positive effect of increased revenues. The same thing happens in the Suburban area 1 (c). In the other cases (b & d), the networks are coverage-limited, and there's plenty of capacity available for more subscribers, without new investments.

7 Conclusions

During the past year or so, the emerging IEEE 802.16-based FWA standards have gained a lot of publicity. These so-called WiMAX networks have been hyped to be able to provide 70 Mbps connections to hundreds of subscribers in non-line-of-sight conditions over a distance of tens of kilometers. Mistakenly, some non-technical sources claim all of these capabilities to exist in a single system at the same time. Although each one of the capabilities may be achieved individually, trade-offs between coverage, capacity, and cost have to be made. Understanding these trade-offs is necessary when assessing the economic feasibility of the networks.

In the thesis, a techno-economic analysis was carried out to determine the feasibility and competitiveness of IEEE 802.16a-based FWA networks in providing broadband Internet access to residential customers.

7.1 Results and recommendations

7.1.1 Coverage and capacity

In the thesis, the FWA networks were analyzed from the point of view of residential broadband services. For these services, the non-line-of-sight capability was seen as a must, giving the possibility for blanket coverage of service areas and easier service provisioning. The requirement for non-line-of-sight capability straightforwardly led to the decision of using the 3.5 GHz licensed FWA frequency band and systems conforming to the IEEE 802.16a standard. In urban and suburban areas, the maximum radius of a single FWA sector was calculated to be 0.5 km in the case of user-installable indoor CPEs, and 1.5 km when using CPEs with outdoor antennas. In rural areas, a range of 10 km was considered reasonable for line-of-sight links attenuated by vegetation.

The average capacity of the FWA sectors was calculated to be about 15 Mbps, which makes the systems uncompetitive against e.g. VDSL systems in densely populated areas. Higher throughputs and sector capacities would be available only in the higher frequency bands, where the frequency allocations are substantially higher. The use of higher frequency bands such as the 26 GHz FWA band would, however, make non-line-of-sight transmissions impossible.

7.1.2 Economic analysis

The results of the economic analysis show that the cost structure of FWA networks is currently not competitive with ADSL in densely populated urban and suburban areas. This results from a relatively low coverage and range of the networks, and high prices of equipment.

In most of the scenarios analyzed in the thesis the FWA networks are coverage-limited. This means that the coverage-based number of base stations is higher than what would be required to fulfill the aggregate capacity requirements of the subscribers. Therefore, large investments are required already in the early phases of network deployments, when the number of subscribers is low.

The analysis also highlighted the high cost of FWA CPEs. For the purpose of providing simple broadband access services to households, the price of 500-750€ per CPE is very high. It takes a lot of time for the operator to collect the price of the CPEs as service revenues from subscribers.

Based on the analysis, user-installable indoor CPEs may become a feasible alternative only on the most densely populated areas. The use of indoor CPEs decreases the range of the FWA base stations to about a third of the range in the case of outdoor CPEs. This increases the required number of base stations significantly. Since in most cases the FWA networks are coverage-limited already when using outdoor CPEs, the use of indoor CPEs is not feasible.

Attention should be paid also to the cost of backbone connections. Since the FWA base stations are likely to be mounted in towers and high buildings, point-to-point radio links are a good alternative for providing the backbone transmission. When the number of FWA base stations gets high, e.g. because of coverage limitations, the cost of these transmission links becomes also significant. The existence of fiber backbone networks is in an important role when assessing the FWA business opportunities.

7.1.3 Recommendations

Currently, FWA networks are not a significant threat to established ADSL or cable modem operators. Based on the results, new entrants are more likely to use DSL technologies over unbundled subscriber lines. In sparsely populated rural areas not

connected to fiber backbone networks, the FWA may be a more cost-effective way to provide broadband access to households. In these areas, however, the profitability is poor for all technologies.

The high cost of FWA CPEs should be taken into account when considering FWA business plans. The cost could e.g. be shared among many subscribers. Multi-dwelling unit connections for apartment houses might be an interesting market from FWA network point of view. FWA network connections could also be divided between multiple households in a neighborhood by using low-cost WLAN access points and CPEs to provide the connection for the last hundred meters or so.

In the thesis, FWA networks were analyzed as a new technology providing existing services to existing markets. The networks, however, give possibilities for operators to introduce also new types of broadband services. According to Intel's view, IEEE 802.16a-based radios will eventually be integrated into motherboards of portable devices such as laptops. This enables the use of the broadband connection not only at home, but everywhere inside the network coverage area. The value of these services for the customer is still unclear, but they will surely make the FWA business case more positive. Further study is required for more accurate positioning of FWA technologies among the networks of the future.

7.2 Reliability and validity

Reliability of the "hard" figures from the techno-economic analyses performed in this thesis can be questioned. Before proceeding to the calculations, a vast number of assumptions and predictions were made, e.g. on the broadband service penetration and price evolution, degree of competition in the market, and network component price evolution. Each of the assumptions and predictions holds a degree of uncertainty, meaning that the NPV values and payback periods of actual network projects are likely to be somewhat different than those calculated in the thesis.

However, in these kinds of analyses, one shouldn't only stare at single NPV figures or payback periods. Understanding of the business prospects of FWA networks requires understanding of the most important parameters affecting the outcomes of the analyses. For this purpose, the sensitivity analyses carried out in the thesis proved to be valuable.

Perhaps the largest amount of uncertainty in the results of the thesis relates to the achievable coverage areas of the FWA networks. The coverage planning and network dimensioning for urban and suburban areas were based on link budget calculations using a path loss model from Erceg et al. (1999 & 2003). The path loss model was originally created from measurements near 2 GHz frequencies, which makes its use on the 3.5 GHz somewhat questionable. The actual coverage of the base station sectors should be evaluated in field trials.

7.3 Suggestions for future research

7.3.1 Channel models

Studies or test results regarding channel and path loss models for FWA links around 3.5 GHz have apparently not been published. This makes it difficult to predict the coverage areas of the base station sectors, which of course is of great importance when determining the economic feasibility of the networks. Extensive testing should be carried out for both line-of-sight and non-line-of-sight links in urban, suburban, as well as rural environments.

7.3.2 Advanced services and business models

The business model treated in the thesis was very simple: to provide fixed broadband Internet access for households. This somewhat undervalues the FWA technologies, as the same systems can be used to provide many other kinds of services. The following considerations could be added to the business and economic models of the thesis:

- **Mobility:** Service tariffs could be higher if the customers were able to roam around in a network and have broadband access from various places. This will be possible in the near future as the FWA CPEs are integrated to e.g. the motherboards of laptop computers.
- **Quality of service:** The QoS capabilities of standards-based FWA networks are very good. Increased revenues could be achieved by offering e.g. IP telephony or video-on-demand capabilities as a part of the service offering.
- **WLL services:** In some cases, e.g. sparsely populated rural areas, FWA networks could be used to completely replace the existing copper telephone lines that are often so-called pole-lines and have high operating costs.

- Business customers: Instead of concentrating only on the price sensitive residential market, FWA operators could find sources of new revenues from the SMEs and large enterprises.
- MDU connections: Cost savings could be found by providing services for multi-dwellings instead of individual subscribers.
- Transmission networks: FWA networks could be used as transmission links for WLAN hotspots and cellular base stations.

It is clear that FWA technologies can be used to provide many different kinds of services for many different kinds of markets. One operator could integrate many or even all of the above-mentioned aspects to their business model. Further study is required in order to find out the exact services and markets in which the FWA technologies will prove to offer real benefits over other networking technologies.

8 References

ANDERSON, H.R., 2003. Fixed Broadband Wireless System Design. West Sussex: John Wiley & Sons Ltd.

ANTTILA, A., 2003. Peer to Peer and ISPs' Survival Strategies. In: R. Kantola, 2003, ed. Peer to Peer and SPAM in the Internet. Espoo: Helsinki University of Technology. Available from: <http://netlab.hut.fi/opetus/s38030/F03/Report-p2p-spam-2003.pdf> (Accessed 31.03.2004).

ASYMMETRIC DIGITAL SUBSCRIBER LINE FORUM, 1997. ADSL Forum System Reference Model. ADSLForumTR-001. Available from: http://www.dslforum.org/aboutdsl/adsl_reference_model.html (Accessed 31.03.2004).

BARRASS, H., 2003. IEEE 802.3ah Ethernet in the First Mile – Copper Overview. Palo Alto: Stanford University. Available from: http://tellurite.stanford.edu/snrc-access/presentations/barrass_060503.pdf (Accessed 30.09.2003).

BOUILLON, Y., ELNEGAARD, N., KATSIANIS, D., WELLING, I., OLSEN, B., ZAGANIARIS, A., 2002. Report on Tool and Methodology. Deliverable 7 from IST-2000-25172 TONIC.

BREALEY, R.A., MYERS S.C., 2000. Principles of Corporate Finance. 6th ed. New York: McGraw-Hill.

BREDBANDSBOLAGET, 2003. Company Web Site. Available from: <http://en.bredband.com/> (Accessed 25.09.2003).

CABLELABS, 2002. Data-Over-Cable Service Interface Specifications, Radio Frequency Interface Specification. SP-RFIV2.0-I02-020617. Available from: <http://www.cablemodem.com/specifications/> (Accessed 31.03.2004).

CELTIC, 2004. CELTIC Initiative Web Site. Available from: <http://www.celtic-initiative.org/> (Accessed 31.03.2004).

COMMISSION OF THE EUROPEAN COMMUNITIES, 2002. Telecommunications Regulatory Package, Eighth Implementation Report, Annex I. Available from: http://europa.eu.int/information_society/topics/telecoms/implementation/index_en.htm (Accessed 31.03.2004).

CORDIS, 2003. Community Research & Development Information Service Web Site. Available from: <http://www.cordis.lu> (Accessed 13.09.2003).

DIAB, W., 2003. IEEE 802.3ah Ethernet in the First Mile - Optics and EPON. Palo Alto: Stanford University. Available from: http://wdm.stanford.edu/snrc-access/presentations/diab_060503.pdf (Accessed 30.09.2003).

ERCEG, V., GREENSTEIN, L.J., TJANDRA, S.Y., PARKOFF, S.R., GUPTA, A., KULIC, B., JULIUS, A.A. & BIANCHI, R., 1999. An Empirically Based Path Loss Model for Wireless Channels in Suburban Environments. IEEE Journal on Selected Areas in Communications, July 1999.

ETHERNET IN THE FIRST MILE ALLIANCE, 2002. Ethernet in the First Mile. Making Universal Broadband Access a Reality. Available from: http://www.efmalliance.org/EFMAwhitepaper_0531.pdf (Accessed 5.9.2003).

ETSI EN 301 021, 2003. Fixed Radio Systems; Point-to-multipoint Equipment; Time Division Multiple Access (TDMA); Point-to-multipoint Digital Radio Equipment in Frequency Bands in the Range 3 GHz to 11 GHz. V1.6.1.

ETSI EN 301 192, 2003. Digital Video Broadcasting (DVB); DVB Specification for Data Broadcasting. V1.3.1.

ETSI ETS 300 801, 1997. Digital Video Broadcasting (DVB); Interaction Channel through Public Switched Telecommunications Network (PSTN) / Integrated Services Digital Networks (ISDN).

ETSI TR 101 856, 2001. Broadband Radio Access Networks (BRAN); Functional Requirements for Fixed Wireless Access Systems below 11 GHz: HIPERMAN. V1.1.1.

ETSI BRAN, 2003. BRAN Summary. Available from: <http://portal.etsi.org/bran/Summary.asp> (Accessed 14.07.2003).

FINNISH COMMUNICATIONS REGULATORY AUTHORITY, 2003. Wireless Local Loop License Holders and Spectrum Assigned on WLL bands. Available from: <http://www.ficora.fi/englanti/document/WLL.pdf> (Accessed 4.3.2004).

FINNISH COMMUNICATIONS REGULATORY AUTHORITY, 2004. Frequency Plan. Available from: <http://www.ficora.fi/englanti/radio/taulu.htm> (Accessed 4.3.2004).

HOMEPLUG POWERLINE ALLIANCE, 2003. Web Site. Available from: <http://www.homeplug.com/> (Accessed 31.03.2004).

HOYMANN, C., PÜTTNER, M., FORKEL, I., 2003. The HIPERMAN Standard - a Performance Analysis. In: Proceedings of the IST Mobile & Communication Summit 2003, Aveiro Portugal, June 2003. Available from: http://www.comnets.rwth-aachen.de/publications/C_Hoymann.html (Accessed 31.03.2004).

IBE, O.C., 2002. Fixed Broadband Wireless Access Networks and Services. New York: John Wiley & Sons, Inc.

IEEE 802.11, 2003. Working Group Web Site. Available from: www.ieee802.org/11/ (Accessed 31.03.2004).

IEEE Standard 802-2001. IEEE Standard for Local and Metropolitan Area Networks: Overview and Architecture.

IEEE Standard 802.16-2001. Part 16: Air Interface for Fixed Broadband Wireless Access Systems.

IEEE Standard 802.16a-2003. Part 16: Air Interface for Fixed Broadband Wireless Access Systems - Amendment 2: Medium Access Control Modifications and Additional Physical Layer Specifications for 2–11 GHz.

ITU-R Recommendation F.1399-1. Vocabulary of Terms for Wireless Access.

ITU-R Recommendation P.833-4. Attenuation in Vegetation.

ITU-T Recommendation I.113. Vocabulary of Terms for Broadband Aspects of ISDNs.

ITU-T Recommendation M.60. Maintenance Terminology and Definitions.

JEE, G., RAO, R.D. & CERN, Y., 2003. Demonstration of the Technical Viability of PLC Systems on Medium- and Low-Voltage Lines in the United States. IEEE Communications Magazine, May 2003.

KANGAS, P., 2004. Price level of telecommunications charges in 2003. Publications of the Ministry of Transport and Communications 21/2004. Helsinki: Edita Publishing Ltd.

KELLY, P., & SARAJEDINI, A., 2002. Evaluating FWA System Performance in NLOS Environments: Observations and Results. In: Proceedings of WCA's 8th Annual Technical Symposium, San Jose, January 2002.

KÄÄRIÄINEN, M., 2000. Broadband to Everybody? Technical and Financial Viability in Finland. Publications of the Ministry of Transport and Communications Finland 41/00. Helsinki: Edita Ltd.

KÄÄRIÄINEN, M., 2003. Fibre Cable in Finnish Backbone and Regional Networks in 2002. Publications of the Ministry of Transport and Communications Finland 20/2003. Helsinki: Edita Plc.

LÄHTEENOJA, M., MONONEN, J., TAHKOKORPI, M., WELLING, I., FLEUREN, F., DRIESKENS, M., GIESCHEN, N. & MARKATOS, S., 1998. Modelling in TITAN. In: L.A. IMS, ed. Broadband Access Networks, Introduction Strategies and Techno-economic Evaluation. London: Chapman & Hall.

MAEDA, Y., OKADA, K., FAULKNER, D., 2001. FSAN OAN-WG and Future Issues for Broadband Optical Access Networks. IEEE Communications Magazine, December 2001.

MIETTINEN, 2003. Datasähkö - uusi vaihtoehto laajakaistaiseksi liittyntäväyläksi. SähköForum 2003. Available from: <http://www.sahko.hut.fi/sahkoforum.html> (Accessed 31.03.2004).

MINISTRY OF TRANSPORT AND COMMUNICATIONS FINLAND, 2002. On the Fees of the Finnish Telecommunications Regulatory Authority. Decree of the Ministry of Transport and Communications, 1126/2002. Available from: <http://www.mintc.fi/www/sivut/suomi/tele/saadokset/telecom/norms/1126-2002en.htm> (Accessed 31.03.2004).

MINISTRY OF TRANSPORT AND COMMUNICATIONS FINLAND, 2003. Communications Market Act. Unofficial translation. Available from: http://www.mintc.fi/www/sivut/dokumentit/viestinta/tavoite/communications_market_act.pdf (Accessed 31.03.2004).

MURCH, R.D. & LETAIEF, K.B., 2002. Antenna Systems for Broadband Wireless Access. IEEE Communications Magazine, April 2002.

OJANIEMI, A. & PUUMALAINEN, J., 2002. Regional Supply of Broadband Access Services. Publications of the Ministry of Transport and Communications Finland 21/2003. Helsinki: Edita Plc.

OLSEN, B.T., 1999. OPTIMUM – a Techno-economic Tool. *Elektronikk*, 95 (2/3).

OULUN PUHELIN, 2004. Price List for Operators 1.3.2004. Available from: <http://www.opoy.fi/> (Accessed 31.03.2004).

PALMÉN, K., 2003. Broadband Internet Connections for Residential Housing Areas and Their Business Economic Effects for Network Operators. Thesis (M.Sc.). Helsinki University of Technology.

PAVLIDOU, N., HAN VINCK, A.J., YAZDANI, J., HONARY, B., 2003. Power line communications: state of the art and future trends. IEEE Communications Magazine, April 2003.

PIKE, R. & NEALE, B., 2003. Corporate Finance and Investment, Decisions and Strategies. 4th ed. London: Prentice Hall.

POHJOIS-KARJALAN LIITTO, 2003. Nopeat tietoliikenneyhteydet kylille ja haja-asutusalueille. Available from: <http://www.pohjois-karjala.fi> (Accessed: 31.03.2004).

RADIONET, 2003. Company Web Site. Available from: www.radionet.com (Accessed 30.09.2003).

RAPPAPORT, T.S., 2002. Wireless Communications, Principles and Practice. 2nd ed. Upper Saddle River: Prentice-Hall.

RAVERA, M., BALZARETTI, S., FERRERO, U., DE BORTOLI, M., LÄHTEENOJA, M., MONONEN, J., 1998. Evolutionary Paths and Scenarios. In: L.A. IMS, ed. Broadband Access Networks, Introduction Strategies and Techno-economic Evaluation. London: Chapman & Hall.

TELIASONERA FINLAND, 2004. Price List for Operators. Available from: <http://www.sonera.fi/> (Accessed 31.03.2004).

SAIKANMÄKI, A., ERKKILÄ, V. & HUSBERG, F., 2004. Internet service using terrestrial digital television distribution. Mater-project. Publications of the Ministry of Transport and Communications Finland 4/2004. Helsinki: Edita Publishing Ltd.

STATISTICS FINLAND, 2003a. Telecommunications in Finland 2002. Helsinki: Statistics Finland.

STATISTICS FINLAND, 2003b. Statistics Finland's Web Site. Available from: <http://www.stat.fi> (Accessed 30.09.2003).

STATISTICS FINLAND, 2004. Consumer Survey 2004, February. Helsinki: Statistics Finland.

TISCALI, 2003. Company Web Site. Available from: <http://www.tiscali.fi/> (Accessed 01.09.2003).

VANTAAN ENERGIA, 2003. Company Web Site. Available from: <http://www.vantaanenergia.fi/> (Accessed 31.03.2004).

WIMAX FORUM, 2002. An Introduction to the World Interoperability for Microwave Access (WiMAX) Forum. Available from: <http://www.wimaxforum.org/news/downloads.asp> (Accessed 14.07.2003).

WIMAX FORUM, 2003. WiMAX Overview. Available from: <http://www.wimaxforum.org/news/downloads.asp> (Accessed 14.07.3003).

A Appendices

A.1 National frequency allocations for FWA services

Wireless Local Loop licence holders and spectrum assigned on WLL bands

7.10.2003

3,5 GHz Frequency Band (total frequency band with guard bands is ~ 2 x 80 MHz, block size varies)

Service Area	Operator block 1	Operator block 2	Operator block 3
Helsinki, Espoo, Vantaa, Kauniainen	Vantaan Energia Oy (2 x 28 MHz)	Suomi Communications Oy (2 x 26,25 MHz)	Oy Finland Tele2 Ab (2 x 21 MHz)
Hyvinkää	Riihimäen Puhelin Oy (2 x 28 MHz)	Ertavi Oy (2 x 26,25 MHz)	
Hämeenlinna		Suomi Communications Oy (2 x 28 MHz)	Ertavi Oy (2 x 21 MHz)
Lahti	Oy Finland Tele2 Ab (2 x 21 MHz)	Suomi Communications Oy (2 x 28 MHz)	Ertavi Oy (2 x 21 MHz)
Mäntsälä			Mäntsälän Sähkö Oy (2 x 14 MHz)
Riihimäki		Ertavi Oy (2 x 26,25 MHz)	
Kuusankoski, Kouvola, Mikkeli	Oy Finland Tele2 Ab (2 x 21 MHz)		
Kotka, Lappeenranta	Oy Finland Tele2 Ab (2 x 21 MHz)	Suomi Communications Oy (2 x 28 MHz)	
Hamina			Haminan Energia Oy (2 x 14 MHz)
Imatra	Oy Finland Tele2 Ab (2 x 21 MHz)		
Porvoo	Oy Finland Tele2 Ab (2 x 21 MHz)		Porvoon Energia Oy (2 x 14 MHz)
Puumala			Sonera Entrum Oy (2x19,25 MHz)
Vaasa, Mustasaari	Oy Finland Tele2 Ab (2 x 21 MHz)	Suomi Communications Oy (2 x 28 MHz)	Oy KD-Soft Ab (2 x 19,25 MHz)
Närpiö, Kaskinen		Oy Närpes Dynamo Net Närpiö Ab (2 x 28 MHz)	Oy KD-Soft Ab (2 x 19,25 MHz)
Maalahti, Korsnäs, Maksamaa, Kristiinankaupunki			Oy KD-Soft Ab (2 x 19,25 MHz)
Kauhajoki, Kokkola, Pietarsaari, Seinäjoki	Oy Finland Tele2 Ab (2 x 21 MHz)		
Jyväskylä	Oy Finland Tele2 Ab (2 x 21 MHz)	Suomi Communications Oy (2 x 28 MHz)	Sonera Carrier Networks Oy (2 x 19 MHz)
Pori	Oy Finland Tele2 Ab (2 x 21 MHz)	Suomi Communications Oy (2 x 28 MHz)	Sonera Carrier Networks Oy (2 x 19 MHz)
Kuopio, Joensuu	Sonera Carrier Networks Oy (2 x 28 MHz)	Suomi Communications Oy (2 x 28 MHz)	
Oulu area	Sonera Carrier Networks Oy (2 x 28 MHz)	Suomi Communications Oy (2 x 15,75 MHz)	Oy Finland Tele2 Ab (2 x 21 MHz)
Tampere area	Sonera Carrier Networks Oy (2 x 28 MHz)	Suomi Communications Oy (2 x 26,25 MHz)	Oy Finland Tele2 Ab (2 x 21 MHz)
Turku area	Sonera Carrier Networks Oy (2 x 17,75 MHz)	Suomi Communications Oy (2 x 15,75 MHz)	

10,5 GHz Frequency Band (total frequency band with guard bands is 2 x 150 MHz, block size 2 x 30 MHz)

Service Area	Operator 1
Helsinki, Espoo, Vantaa, Kauniainen, Sipoo	Suomi Communications Oy (2 x 30 MHz)

26 GHz Frequency Band (total frequency band with guard bands is 2 x 840 MHz, block size varies)

Service Area	Operator 1	Operator 2
Helsinki, Espoo, Vantaa, Kauniainen, Sipoo	Suomi Communications Oy (2 x 112 MHz)	Jippii Group Oy (2 x 84 MHz) (Helsinki)

There are two licence applications in 3,5 GHz frequency band under processing in the following areas: **Imatra and Kuopio**.

(Ficora 2003)

A.2 FWA spectrum fee calculation

In Finland, an annual spectrum fee is charged for the use of the 3.5 GHz, 10.5 GHz, and 26 GHz FWA bands. The charged amount depends on the frequency range, the frequency band and the geographical area of the network. The spectrum fee is calculated in accordance with a Decree of the Ministry of Transport and Communications Finland and is calculated as follows:

$$\text{Spectrum fee} = K1 * K2 * \left(\frac{\text{frequency band}}{25 \text{ kHz}} \right) * 1896.30 \text{ euros ,}$$

where

- K1 is a frequency band coefficient,
- K2 is a coverage area coefficient, and
- frequency band is the total amount of sub-bands allocated to the radio system.

The size of the coefficient K1 is determined by the frequency band assigned to the license holder. For FWA spectrum licenses it is either 0.5 (3.5 GHz and 10.5 GHz bands) or 0.4 (26 GHz band).

Coefficient K2 is determined by the geographical area of the radio system assigned to the license holder. It is the sum total of the right of use area divided by the whole area of Finland.

For example, if one wishes to have a license for 56 MHz of spectrum in the 3.5 GHz band for a geographical area of 1000 km², the annual spectrum fee would be calculated as follows.

$$0.5 * \frac{1000 \text{ km}^2}{304472.54 \text{ km}^2} * \left(\frac{56000 \text{ kHz}}{25 \text{ kHz}} \right) * 1896.30 \approx 6975.52 \text{ euros .}$$

(MINTC 2002)

A.3 Link budget calculations

Table A.1: Link budget, directional CPE antennas, coverage requirement 90%

System element	Category A (Hilly, heavy trees)	Category B (Intermediate)	Category C (Flat, few trees)	LOS	LOS with vegetation
Transmitter output power (dBm)	25,00	25,00	25,00	25,00	25,00
Transmitter transmission loss (dB)	-2,00	-2,00	-2,00	-2,00	-2,00
Transmitter antenna gain (dBi)	16,00	16,00	16,00	16,00	16,00
Effective radiated power (dBm)	39,00	39,00	39,00	39,00	39,00
Frequency (MHz)	3500,00	3500,00	3500,00	3500,00	3500,00
Path length (km)	0,90	1,19	1,97	60,79	10,00
BS antenna height (m)	30,00	30,00	30,00	-	-
Rx antenna height (m)	6,00	6,00	6,00	-	-
Path loss median	-125,42	-126,70	-128,49	-139,00	-123,32
Building / vegetation penetration loss (dB)	0,00	0,00	0,00	0,00	-15,68
Total median path loss (dB)	-125,42	-126,70	-128,49	-139,00	-139,00
Receiver antenna gain (dBi)	18,00	18,00	18,00	18,00	18,00
Receiver transmission loss	-2,00	-2,00	-2,00	-2,00	-2,00
Median signal level at receiver input (dBm)	-70,42	-71,70	-73,49	-84,00	-84,00
Shadow fading lognormal distribution st dev	10,60	9,60	8,20	-	-
Coverage requirement (%)	90,00	90,00	90,00	-	-
Shadow fade margin (dB)	13,58	12,30	10,51	-	-
Fade margin (dB)	13,58	12,30	10,51	0,00	0,00
Receiver sensitivity (QPSK 1/2)	-84,00	-84,00	-84,00	-84,00	-84,00
Margin (QPSK 1/2)	0,00	0,00	0,00	0,00	0,00

Table A.2: Link budget, directional antennas, coverage requirement 99%

System element	Category A (Hilly, heavy trees)	Category B (Intermediate)	Category C (Flat, few trees)
Transmitter output power (dBm)	25,00	25,00	25,00
Transmitter transmission loss (dB)	-2,00	-2,00	-2,00
Transmitter antenna gain (dBi)	16,00	16,00	16,00
Effective radiated power (dBm)	39,00	39,00	39,00
Frequency (MHz)	3500,00	3500,00	3500,00
Path length (km)	0,53	0,70	1,22
BS antenna height (m)	30,00	30,00	30,00
Rx antenna height (m)	6,00	6,00	6,00
Path loss median	-114,34	-116,67	-119,92
Building / vegetation penetration loss (dB)	0,00	0,00	0,00
Total median path loss (dB)	-114,34	-116,67	-119,92
Receiver antenna gain (dBi)	18,00	18,00	18,00
Receiver transmission loss	-2,00	-2,00	-2,00
Median signal level at receiver input (dBm)	-59,34	-61,67	-64,92
Shadow fading lognormal distribution st dev	10,60	9,60	8,20
Coverage requirement (%)	99,00	99,00	99,00
Shadow fade margin (dB)	24,66	22,33	19,08
Fade margin (dB)	24,66	22,33	19,08
Receiver sensitivity (QPSK 1/2)	-84,00	-84,00	-84,00
Margin (QPSK 1/2)	0,00	0,00	0,00

Table A.3: Link budget, indoor CPEs, coverage requirement 90%

System element	Category A (Hilly, heavy trees)	Category B (Intermediate)	Category C (Flat, few trees)
Transmitter output power (dBm)	25,00	25,00	25,00
Transmitter transmission loss (dB)	-2,00	-2,00	-2,00
Transmitter antenna gain (dBi)	16,00	16,00	16,00
Effective radiated power (dBm)	39,00	39,00	39,00
Frequency (MHz)	3500,00	3500,00	3500,00
Path length (km)	0,31	0,37	0,57
BS antenna height (m)	30,00	30,00	30,00
Rx antenna height (m)	6,00	6,00	6,00
Path loss median	-103,42	-104,70	-106,49
Building / vegetation penetration loss (dB)	-10,00	-10,00	-10,00
Total median path loss (dB)	-113,42	-114,70	-116,49
Receiver antenna gain (dBi)	6,00	6,00	6,00
Receiver transmission loss	-2,00	-2,00	-2,00
Median signal level at receiver input (dBm)	-70,42	-71,70	-73,49
Shadow fading lognormal distribution st dev	10,60	9,60	8,20
Coverage requirement (%)	90,00	90,00	90,00
Shadow fade margin (dB)	13,58	12,30	10,51
Fade margin (dB)	13,58	12,30	10,51
Receiver sensitivity (QPSK 1/2)	-84,00	-84,00	-84,00
Margin (QPSK 1/2)	0,00	0,00	0,00

Table A.4: Link budget, indoor CPEs, coverage requirement 99%

System element	Category A (Hilly, heavy trees)	Category B (Intermediate)	Category C (Flat, few trees)
Transmitter output power (dBm)	25,00	25,00	25,00
Transmitter transmission loss (dB)	-2,00	-2,00	-2,00
Transmitter antenna gain (dBi)	16,00	16,00	16,00
Effective radiated power (dBm)	39,00	39,00	39,00
Frequency (MHz)	3500,00	3500,00	3500,00
Path length (km)	0,18	0,22	0,36
BS antenna height (m)	30,00	30,00	30,00
Rx antenna height (m)	6,00	6,00	6,00
Path loss median	-92,34	-94,67	-97,92
Building / vegetation penetration loss (dB)	-10,00	-10,00	-10,00
Total median path loss (dB)	-102,34	-104,67	-107,92
Receiver antenna gain (dBi)	6,00	6,00	6,00
Receiver transmission loss	-2,00	-2,00	-2,00
Median signal level at receiver input (dBm)	-59,34	-61,67	-64,92
Shadow fading lognormal distribution st dev	10,60	9,60	8,20
Coverage requirement (%)	99,00	99,00	99,00
Shadow fade margin (dB)	24,66	22,33	19,08
Fade margin (dB)	24,66	22,33	19,08
Receiver sensitivity (QPSK 1/2)	-84,00	-84,00	-84,00
Margin (QPSK 1/2)	0,00	0,00	0,00

A.4 Background data for the environmental scenarios

The environmental scenarios of the techno-economic analysis introduced in Chapter 6 are based on the structure and attributes of Finnish municipalities. The related background data used in the modeling is introduced in the following.

A.4.1 Municipality types

Statistics Finland divides the Finnish municipalities in three statistical groups, based on their degree of urbanization. In the grouping, the municipalities are divided by the proportion of the population living in urban settlements and by the population of the largest urban settlement into urban, semi-urban and rural municipalities, as shown in Table A.5. An urban settlement refers to a group of buildings, which are usually less than 200 m apart and which together house at least 200 people. (Statistics Finland 2003b)

Table A.5: Definitions of different municipality types (Statistics Finland 2003b)

Municipality type	Proportion of population living in urban settlements	and / or	Population of the largest urban settlement
Urban	> 90 %	or	> 15000
Semi-urban	60 – 90 %	and	4000 – 15 000
Rural	< 60 %	and	< 15000
	60 – 90 %	and	< 4000

Table A.6: Characteristics of different municipality types (Statistics Finland 2003b)

Municipality type	Amount	Average population	Average geographical area (km ²)	Median of population density (1/km ²)	% of people living inside an urban settlement
Urban	67	44982	542	312	83,7
Semi-urban	73	11639	504	25	71,6
Rural	304	3957	861	10	48,2

Table A.7 shows the numbers of different types of residential buildings in the different municipality types. It also shows the number of dwellings in these buildings, in cursive font below the numbers of buildings.

Table A.7: Finnish Residential Buildings and Dwellings (Statistics Finland 2003b)

Building type Municipality type	Detached houses		Attached houses		Blocks of flats		Total
		Ratio		Ratio		Ratio	
Urban	383 778 411 574	1,07	37 310 185 832	4,98	43 431 988 270	22,75	536 452 1 617 144
Semi-urban	250 382 247 565	0,99	12 650 66 132	5,23	5 832 83 847	15,58	308 664 407 719
Rural	382 074 367 078	0,96	17 381 92403	5,32	3 530 42 970	12,17	473 076 519 153

A.4.2 Urban and suburban areas

When choosing the parameters for urban and suburban areas, data from Helsinki's districts were used. Data from two major districts (southern and central) are shown, representing an urban area. The Kallio district represents a dense urban area, and the northeastern major district a suburban area.

Table A.8: Statistics from some districts of Helsinki

District	Geographic area (km ²)	Households	Household density (1/km ²)	Single dwellings
Kallio district (Sörnäinen, Siltasaari, Linjat, Torkkelinmäki)	2,75	17587	6395	5
Southern major district	17,73	56033	3160	697
Central major district (Kallio, Alppiharju, Vallila, Pasila, Vanhakaupunki)	15,65	46318	2960	981
Northeastern major district (Latokartano, Pukinmäki, Malmi, Suutarila, Puistola, Jakomäki)	36,5	39353	1078	7214

A.4.3 Rural areas

The region of North Karelia is an example of a sparsely populated rural area in Finland. In the region, a study of the possibilities to offer broadband access in the rural villages and areas (Pohjois-Karjalan liitto 2003) has been made. In the study, the technology considered was ADSL. All the PSTN exchanges in the region were divided into one of four groups, as shown in Table A.9. Usually, one exchange area covers one rural village and its surrounding areas.

Table A.9: Telephone exchange areas in rural North Karelia

Group	n	ADSL availability	Estimated upgrade cost to ADSL
1	54	Available	0
2	142	Not available, easy to upgrade	7.000 – 16.000 € per area, total 1.750.000 €
3	32	Not available, quite hard to upgrade	14.000 – 51.000 € per area, total 700.000 €
4	43	Not available, hard to upgrade	29.000 – 70.000 € per area, total 1.250.000 €

The geographical area of North Karelia excluding the city of Joensuu is 17.700 km², giving an average exchange area size of about 65 km². In the area, there are a total of 51.665 households, giving an average household density of about 3 households / km². About 15% of the households are living in multi-dwelling units.

The household density in Group 1 is higher than in areas without ADSL. In fact, over 60% of the households in rural North Karelia are living in these areas. Group 2 consists of exchange areas that require only a DSLAM equipment to enable broadband services, meaning that a broadband connection (e.g. fiber) to the regional network already exists. In groups 3 and 4, investments would have to be made on the regional network also. The average cost of upgrading exchange areas belonging to groups 3 and 4 is 26.000 euros.